

**Toward Universal Access: Americans with Disabilities Act
Sidewalk and Curb Ramp Self-Evaluation Report
for the City of Bellevue**

September 2009

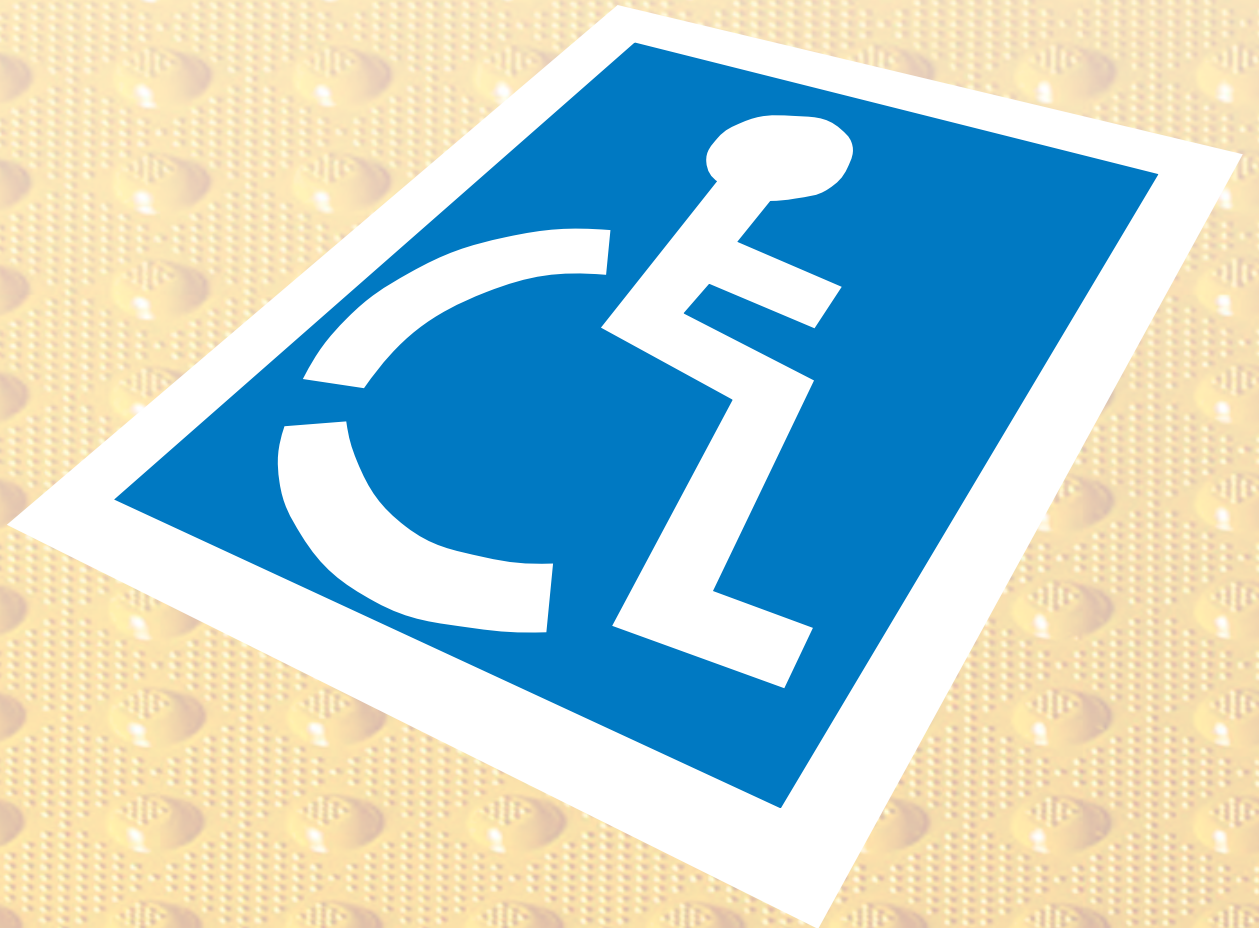

Americans with Disabilities Act & Title VI information

Americans with Disabilities Act (ADA) Information: Materials can be provided in alternative formats by contacting Yvonne Tate, City ADA Coordinator at 425-452-4066 (voice) 425-452-4636 (TTY) or ytate@bellevuewa.gov. Persons who are deaf or hard of hearing may make a request for alternative formats through the Washington Relay Service at 7-1-1.

Title VI Notice to Public: It is the City of Bellevue's policy to assure that no person shall, on the grounds of race, color, national origin or sex, as provided by Title VI of the Civil Rights Act of 1964, be excluded from participation in, be denied the benefits of, or be otherwise discriminated against under any of its federally funded programs and activities. Any person who believes his/her Title VI protection has been violated may file a complaint with the Title VI Coordinator. For Title VI complaint forms and advice, please contact the Title VI Coordinator at 425-452-4270.

ADA Self-Evaluation Report



From the Director of Transportation

The City of Bellevue is committed to establishing an accessible community that provides the public, including persons with disabilities, with access to the transportation network and independent mobility regardless of age, physical constraint, or income. We want all of our citizens to enjoy the benefits of our programs, services, and activities.

In undertaking the Americans with Disabilities Act (ADA) sidewalk and curb ramp self evaluation, the City employed innovative technologies to document barriers and prioritize improvements where they are most needed. Implementation of this technology development and compliance effort involved a coordinated staffing and funding commitment from the City of Bellevue, Federal Highway Administration, and, King County Metro with technical support from Starodub Inc.

The report outcomes were informed by an extensive public outreach effort that provided a wide range of stakeholders from the disability community with improved access to the decision-making process. The outreach effort included surveys, focus groups, public meetings, and conversations with residents at sidewalk and curb ramp locations. The following comment offered by a Bellevue resident with cerebral palsy during a focus group session conveys the importance of this project:

"I think the main issue with my disability and with any disability is that since we can't take our abilities for granted like everyone else can ... by the end of the week having done all my activities, I get exhausted and I don't want to go out and do other activities, and to have these little things go smoother, I think I'd be more willing to go out more and do more things, and be more independent. That's the main issue - having my independence and having my say in what happens around me."

Pedestrian facilities are an essential part of the community infrastructure that individuals use to gain access to the goods, services, and social contacts that support their day-to-day existence and quality of life. People with disabilities are better able to participate in the community if sidewalks and curb ramps are accessible because it is easier for them to reach their desired destinations.

Toward Universal Access: Americans with Disabilities Act Sidewalk and Curb Ramp Self-Evaluation Report for the City of Bellevue pinpoints pedestrian facilities requiring additional assessment and potential modification to ensure that the City's public rights-of-way meet ADA standards. Bellevue Transportation Department staff created this report so that interested persons could review all of this information in a single, easy-to-read document. In addition, this report provides the foundation to the Department's ADA Transition Plan Update.

Sincerely,

A handwritten signature in black ink, appearing to read "Goran Sparrman". The signature is written in a cursive style and is positioned above the printed name.

Goran Sparrman
Director of Transportation
City of Bellevue



Acknowledgements

The City would like to specifically thank the following individuals for their contributions and cooperation in preparing Toward Universal Access: Americans with Disabilities Act Sidewalk and Curb Ramp Self-Evaluation Report for the City of Bellevue.

City of Bellevue Core Staff

Franz Loewenherz, Senior Transportation Planner

Michael Bishopp, Senior GIS Analyst

Zorba Conlen, Senior GIS Analyst

Other City of Bellevue Staff Contributors

Jen Benn, Transportation ADA Coordinator

John Perez, GIS Specialist

Kurt Latt, Senior Transportation Engineer

Matt Yarrow, Inventory Specialist

Patrick McGrath, Transportation Planning Intern

Phyllis Hall, Graphic Designer

Rachel Wilch, Inventory Specialist

Sarah Squires, Transportation Planning Intern

Zachary Howard, Transportation Planning Intern

Other Agency Contributors

Jim Mekemson, Starodub, Inc.

Mark Swanlund, Federal Highway Administration

Spencer Cotton, King County Metro

Disability Community Participants

Beth Jurco

Dan Ray

David Egan

Dinesh Indurkar

Jay Karns

Jelica Nuccio

John Molloy

Larry Showalter

Marie Ray

Mark Landrenau

Michael Moran

Rima Saha

Vijay Advani

Table of Contents



Page No.

1. Introduction	4
Policy Commitment.....	4
Demographic Trends	4
Project Purpose	5
Summary Findings	6
2. Project Approach.....	10
Phase 1. Data Collection	10
Phase 2. Database Analysis.....	13
Phase 3. Barrier Ranking.....	17
Disability Community Participation.....	28
3. Sidewalk Inventory.....	31
Obstructions.....	31
Changes in Level.....	42
Grade (Running Slope).....	46
Cross Slope.....	50
Sidewalk Barrier Ranking Analysis.....	53
4. Curb Ramp Inventory.....	56
Methodology.....	56
Curb Ramp Categories.....	57
Curb Ramp Assessment.....	62
Curb Ramp Barrier Ranking Analysis.....	70

Sidewalk and Curb Ramp Maps and Spreadsheets

The maps and spreadsheets associated with the ADA sidewalk and curb ramp inventory are located in a Technical Appendix Report at <http://www.bellevuewa.gov/accessibility-reports.htm>



ADA Self-Evaluation Report



"I have spina bifida, curvature of the spine, and hydrocephalus – water on the brain – that affects my ability to get around."
~ Bellevue resident for 30 years

Access to civic life by people with disabilities is a fundamental goal of the Americans with Disabilities Act (ADA). To ensure that this goal is met, Title II of the ADA requires state and local governments to make their programs and services accessible to persons with disabilities (28 CFR 35.149-35.151). This requirement extends not only to physical access at government facilities, programs, and events -- but also to pedestrian facilities in public rights-of-way.

Policy Commitment

The City of Bellevue has a long and distinguished history of working to address the transportation needs of its residents with disabilities. On November 16, 1992, the Bellevue Council adopted Resolution 5586 establishing a program to promote full participation for all people who use city services and programs. In April 1997, Bellevue received a Certificate of Appreciation from the Governor’s Committee on Disability Issues and Employment. The award focused on making facilities accessible, addressing access barriers to internal and external customers, and providing flexibility in the workplace.

The City of Bellevue remains committed to ensuring that the civil rights of people with disabilities are preserved and that it complies with ADA regulations pertaining to these rights. Bellevue’s Comprehensive Plan (Policy TR-26) directs staff to: Address the special needs of physically challenged and disabled citizens in planning, designing, implementing, and maintaining transportation improvements,

particularly non-motorized improvements, and other transportation facilities, and in delivering transportation services and programs, in accordance with the Americans with Disabilities Act. This policy commitment is carried forward in all phases of project and service development provision.

% Population 65+ (Central Puget Sound)

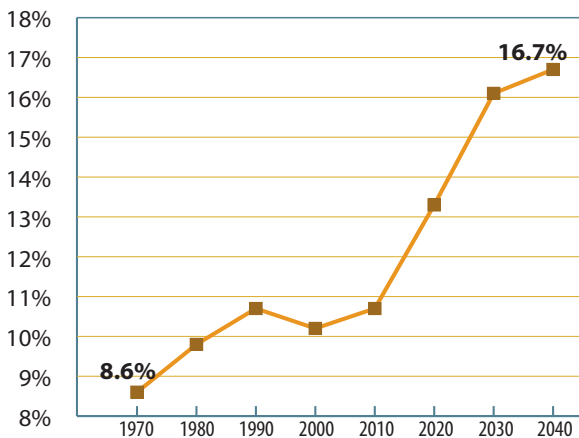

Demographics Trends

The City of Bellevue is a community of 120,000 residents. According to the 2000 Census, approximately 15 percent of Bellevue residents live with a developmental, physical, or mental disability. The following list indicates the Census categories of disabilities and approximate number of people in each group for Bellevue (note: one

Introduction



person could be included in multiple categories): sensory: 3,100; physical: 6,400; mental: 4,350; self-care: 2,200; go-outside-home: 6,100; and, employment: 7,800.

Building pedestrian facilities now and for the future means taking into consideration not only the reported disabilities of residents but also the physical and cognitive changes that many individuals experience over the course of their lifetimes. Looking to the future, an increased percentage of the population with disabilities is expected as the category of citizens 75 years of age and older is growing at a rate more than four times as fast as the general population in Bellevue. It is estimated that 85% of Americans who live to their full life expectancy will suffer a permanent disability.

Project Purpose

The ADA requires every state and local government to prepare a self-evaluation plan to identify program access issues. In 2008, Bellevue undertook an ADA sidewalk and curb ramp self-evaluation update to assess its program accessibility responsibilities for existing pedestrian facilities in the public rights-of-way.

The 2009 ADA Sidewalk and Curb Ramp Self-Evaluation Report is a comprehensive analysis of the city's existing sidewalk and curb ramp facilities. Data collected from this assessment enables city staff to: (i) determine if a sidewalk or curb ramp meets intended design specifications and guidelines; (ii) catalog feature and maintenance information; (iii) identify portions of sidewalks needing accessibility improvements; (iv) quantify the extent of the work required; and, (v) add pedestrian information to the City's Geographic Information Systems (GIS) database. The barrier ranking analysis used in this process was the product of a public consultation process, which the City believes reflects the interests of Bellevue residents and responds to the stated needs of people with disabilities in the community.

Bellevue's ADA Transition Plan Update references the barrier rankings of non-standard pedestrian facilities documented in the ADA Sidewalk and Curb Ramp Self-Evaluation Report to identify corrective measures in the city's public rights-of-way. Recognizing that the City has limited funds and cannot immediately make all sidewalks and curb ramp facilities fully accessible, the City's ADA Transition Plan sets

Relationship between the Self-Evaluation Report and the ADA Transition Plan

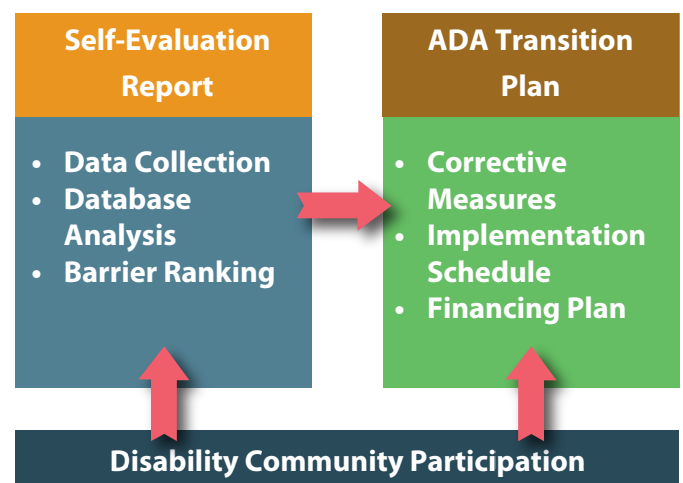



ADA Self-Evaluation Report

forth the schedule for making access modifications. The City of Bellevue reserves the right to update the barrier removal priorities to allow flexibility in accommodating community requests, petitions for reasonable modifications from persons with disabilities, and changes in City programs.

Summary Findings

To comply with ADA requirements, sidewalks and curb ramps must meet specific standards for width, running slope, cross slope, placement, and other features. The ADA Sidewalk and Curb Ramp Self-Evaluation project generated a significant amount of data regarding the accessibility of public rights-of-way in Bellevue.



Fixed obstructions.

Sidewalk Data - Detailed documentation on the accessibility of Bellevue sidewalks is found on pages 31 through 55 of this report, and in the technical appendix report.

1. Sidewalk surface type
 - Sidewalk facilities: 321 miles
 - Concrete surfaces: 298 miles
 - Asphalt/brick/other surfaces: 23 miles
2. Sidewalk obstructions
 - Fixed obstructions: 226 instances
 - Movable obstructions: 722 instances
 - Vegetative obstructions: 5,996 instances
3. Sidewalk changes in level
 - Total: 27,558 instances
 - 0.25" - 0.5": 20,002 instances
 - 0.51" - 0.75": 7,014 instances
 - 0.76" - 1": 274 instances
 - > 1": 268 instances



Change in level.

Introduction



4. Non-standard sidewalk grade

- Total: 39 miles
- 5% - 8.33%: 32 miles
- 8.34% - 10%: 4 miles
- 10.1% - 12.5%: 2 miles
- > 12.5%: 1 mile
- Deemed technically infeasible: 95 miles

5. Non-standard sidewalk cross slope

- Total: 212 miles
- 2 - 4%: 134 miles
- 4.1 - 6%: 49 miles
- 6.1 - 8%: 15 miles
- 8.1 - 10%: 7 miles
- > 10%: 7 miles

6. Sidewalks with either a non-standard cross slope or grade

- Including grade deemed technically infeasible: 254 miles
- Excluding grade deemed technically infeasible: 225 miles

Curb Ramp Data - Detailed documentation on the accessibility of Bellevue curb ramps is found on pages 56 through 72 of this report, and in the technical appendix report.

1. Ramp type data

- Ramp locations: 4,586
- Perpendicular ramp configuration: 1,175
- Parallel ramp configuration: 1,352
- Directional ramp configuration: 674
- Diagonal ramp configuration: 235
- Island/median ramp configuration: 75
- Sidewalk locations lacking ramp access (non-standard): 1,041
- Ramp inaccessible due to construction: 34



Vegetation and grade barriers.



Steep driveway cross slope.



Missing ramp.



ADA Self-Evaluation Report



Barrier forces street use.



Encroaching vegetation on ramp.



Steep ramp flare slope.

2. Returned curb data
 - Standard locations: 306
 - Non-standard locations: 11
3. Flare data
 - Slopes $\leq 10\%$ (standard): 457
 - Slopes between 10.1% – 12% (non-standard): 225
 - Slopes $> 12\%$ (non-standard): 765
4. Ramp landing panel data
 - Depth greater than or equal to 48" (best practice): 2,276
 - Depth between 36" - 48" (standard): 283
 - Depth smaller than 36" (non-standard): 161
 - None present (non-standard): 791
 - Slopes $> 2\%$ (non-standard): 2,791
5. Ramp panel data
 - Width greater than or equal to 48" (best practice): 2,211
 - Width between 36" - 47" (standard): 1,199
 - Width $< 36\%$ (non-standard): 101
 - Running slope $< 8.3\%$ (standard): 1,525
 - Running slope between 8.31% - 10% (non-standard): 686
 - Running slope $> 10\%$ (non-standard): 1,300
 - Cross slope $\leq 2\%$ (standard): 1,095
 - Cross slope between 2% - 4% (non-standard): 1,006
 - Cross slope $> 4\%$ (non-standard): 1,410
 - Ramps with both running slope $< 8.3\%$ (standard) and cross slope $< 2\%$ (standard): 502
 - Ramps with both running slope $> 10\%$ (non-standard) and cross slope $> 4\%$ (non-standard): 593

Introduction



6. Gutter data

- Running slope $\leq 5\%$ (standard): 2,362
- Running slope $> 5\%$ (non-standard): 1,149
- Cross slope $\leq 2\%$ (standard): 1,302
- Cross slope $> 2\%$ (non-standard): 2,209
- Non-standard gutter/ramp transitions: 713

7. Ramps lacking detectable warning surface (non-standard)

- Total: 2,557



Missing detectable warning surface.

8. Marked crossings

- Ramps without marked crossings: 2,869
- Ramps with one marked crossing: 500
- Ramps with two marked crossings: 142
- Diagonal ramps lacking 48" clear space (non-standard): 78



No ramp landing panel.



Steep ramp running slope.



ADA Self-Evaluation Report



The ADA Self-Evaluation Report took shape out of the following three-phased approach: (i) data collection; (ii) database analysis; and, (iii) barrier ranking. As indicated in the visual representation on the left, the self-evaluation process arose from a collaborative, interdisciplinary approach involving the disability community in the identification of priorities for improving pedestrian accessibility in Bellevue.

Phase 1. Data Collection

The traditional ADA inventory process is time-consuming and imprecise. Most jurisdictions undertaking ADA sidewalk and curb ramp inventory efforts rely on data collectors to choose between a “yes” or “no” to record ADA compliance. While this enables jurisdictions to quickly collect data, the “yes/no” clipboard approach does not offer jurisdictions a precise understanding of which areas have the most need. Bellevue determined that a new solution to quickly and accurately document the type, severity, and location of sidewalk and ramp barriers in the City would be most efficient.

In 2006, the City of Bellevue began an ADA self-evaluation to document existing physical barriers for persons with disabilities. Bellevue considered a number of options for gathering data on its 321 miles of sidewalk and 4,586 curb ramps, including traditional survey and light detection and ranging (LIDAR). Based on early tests, the City concluded that either of these approaches could cost more than \$1 million.

City staff learned about inertial profiler systems that had been in use since the 1970s to measure pavement defects. An interdepartmental team at the City of Bellevue partnered with federal and regional agencies to adapt this profiler technology to the task of inventorying and mapping the degree to which sidewalks and curb ramps in the City’s right of way meet ADA standards.

Project Approach



The technology, developed through a pilot program with the Federal Highway Administration, uses an Ultra-Light Inertial Profiler (ULIP) mounted on a Segway scooter. The device's displacement laser, three accelerometers, optical trigger, distance measurement instrument, and gyroscope are designed to measure the sidewalk surface at a rate of 10,000 records per second. Together, these devices capture highly accurate information about slope and small surface variations that can make a sidewalk difficult to navigate. A tray and handle bar mount support a notebook computer that offers an interactive, real-time display during data collection. The accompanying software produces a text file compatible with the City's Geographic Information Systems (GIS) asset management database.

Bellevue staff worked with colleagues at the Federal Highway Administration and King County to ensure that the resulting technology would be of broad benefit to federal, state, and local government entities. From a cost savings perspective, the total project expense of \$285,000 in staffing, software, and hardware reflects a 70 percent savings over the amount originally estimated to conduct a traditional survey or light detection and ranging approach. Specific partnership contributions included:

- City of Bellevue – Staff in both the Transportation and IT Departments collaborated in overseeing this project. Staff managed the three-agency partnership, field tested the technology, verified results using other measurement systems, collaborated with FHWA and Starodub, Inc. engineers to refine the software, and developed programming scripts that synthesize ULIP data records into the city's GIS system. These staffing costs are estimated to be \$70,000.
- Federal Highway Administration (FHWA) – FHWA is responsible for ensuring access for persons with disabilities to pedestrian facilities within the public right-of-way. The Office of Pavement Technology agreed to have Starodub, Inc. fabricate the ULIP (at an estimated cost of \$120,000) in 2006. The device was loaned to Bellevue at no cost to the city. FHWA provided an additional \$50,000 in 2007 for software refinements.
- King County – As a transit operator in the region, King County is responsible for the provision of ADA curb-to-curb paratransit service as a safety net for persons whose disabilities prevent



City of Bellevue's ULIP and Segway Human Transporter Equipment.

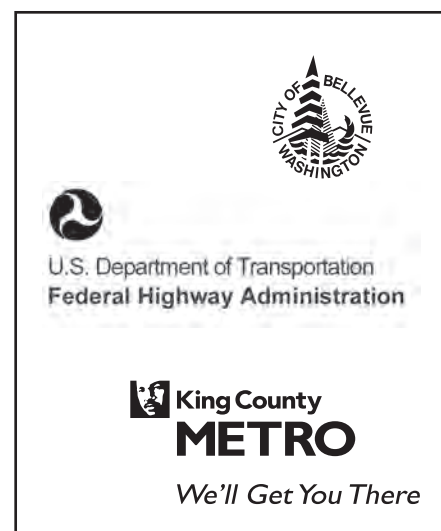

Implementation of this technology development and compliance effort involved a coordinated staffing & funding commitment from three agencies from three levels of government.



ADA Self-Evaluation Report

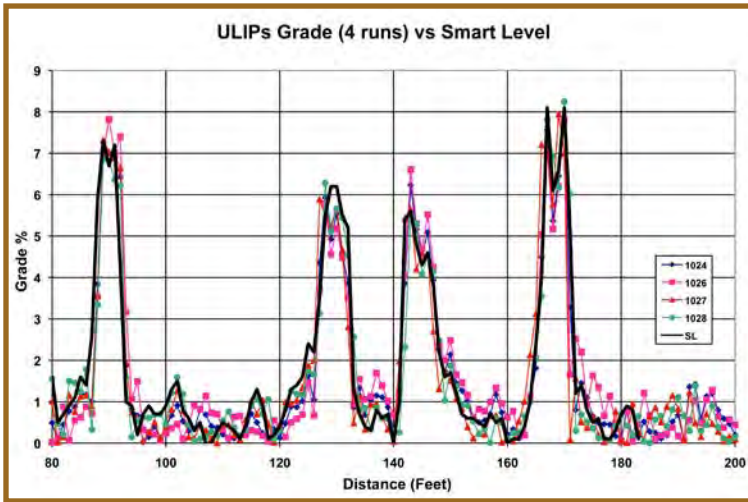

This validation testing graph shows very good agreement between the ULIP and smart level data.



Before and after screen shots comparing the positional accuracy of spatial data from: (i) streaming GPS (top) - found to be unreliable; and (ii) from sensor based inertial navigation (bottom) - found to offer better map matching capability.

use of accessible non-commuter, fixed route bus service. The Department of Accessible Services regards the data generated from the ULIP technology as saving time and money they would otherwise spend conducting accessible pathway assessments. For the opportunity to partner in Bellevue’s research endeavor, King County provided \$45,000 to support the two staff members involved in the inventory process and assisted with the public outreach process.

Because it was a new technology, the City of Bellevue sought confirmation that data acquired from the ULIP platform was reproducible and accurate. During the 2007 trial period, Bellevue and Starodub, Inc. staff undertook numerous tests comparing grade and cross slope measurements from the ULIP and alternative measurement devices (e.g., digital smart level readings) before a decision was made to employ this technology citywide.

Bellevue testing with global navigation satellite system (GPS) found the accuracy of latitude/longitude data degraded in areas with tall buildings or thick tree canopies. As reflected in the images at left, GPS would have required labor-intensive post processing and quality assurance and quality control (QA/QC) iterations.

A sensor-based inertial navigation system integrated with an ESRI ArcPad interface enhanced the accuracy of the spatial data in the inventory. To establish travel path control points, field technicians entered the start and end points for each data

Project Approach



collection run on an ortho-photo image on the ULIP's notebook computer screen. The gyroscope, accelerometers and distance measurement instrument in the sensor box were used to compute the ULIP's relative path of travel. The relative travel path was combined with the control points to produce a travel path consistent with the city's GIS system.

During the 2008 citywide inventory effort, the city employed QA/QC protocol for validation testing of the software and hardware. The ULIP technology's efficacy was confirmed in 2008, when two field technicians were able to inventory the city's entire pedestrian system within a few months' time. One technician operated the ULIP and conducted the sidewalk inventory (321 miles), and a second technician rode a bicycle and used a Topcon GMS-2 handheld GPS receiver to conduct the curb ramp inventory (4,586 locations).

After several years in development, the ULIP platform is the first technology of its kind to enable jurisdictions to quickly, accurately, and comprehensively complete an ADA condition assessment inventory. Bellevue's ULIP-based approach is distinguished from the efforts of other jurisdictions because actual values for running slope, cross-slope, and vertical separation are captured along sidewalk block faces; as compared to a simplistic "yes-no" compliance determination by field staff quickly traversing a city's sidewalk network. [A block-face is one side of a street between two consecutive intersections.]

The technical precision offered by Bellevue's approach is identified as a best practice in *ADA Compliance at Transportation Agencies: A Review of Practices* (NCHRP 20-07 Task 249), a National Cooperative Highway Research Program study. The report notes that "[e]fforts such as those at the City of Bellevue, Washington, that rely on the collection of large datasets at extremely fine spatial and temporal disaggregation levels have the potential to significantly automate the identification of non-compliant locations in the field."

Phase 2. Database Analysis

The City of Bellevue's ADA sidewalk and curb ramp database provides staff with geographic data with both: (i) positional accuracy, the digital representation of a barrier conforms to the actual location found in the field (better than what is possible with streaming GPS); and, (ii) attribute accuracy, the digital representation of a barrier is represented in a manner consistent with actual conditions found in the field (% running slope, % cross-slope, inches of vertical separation, etc.). Defining

ADA COMPLIANCE AT TRANSPORTATION AGENCIES: A REVIEW OF PRACTICES

Requested by:

American Association of State Highway
and Transportation Officials (AASHTO)

Standing Committee on Highways

Prepared by:

Cesar Quiroga, Ph.D., P.E.
Research Engineer

and

Shawn Turner, P.E.
Research Engineer

TEXAS TRANSPORTATION INSTITUTE
The Texas A&M University System
College Station, Texas

September 2008

The information contained in this report was prepared as part of NCHRP Project 20-07, Task 249, National Cooperative Highway Research Program, Transportation Research Board

Bellevue's ADA inventory compliance efforts are nationally recognized.



ADA Self-Evaluation Report

Averaging Window Size Effect on Grade (%)

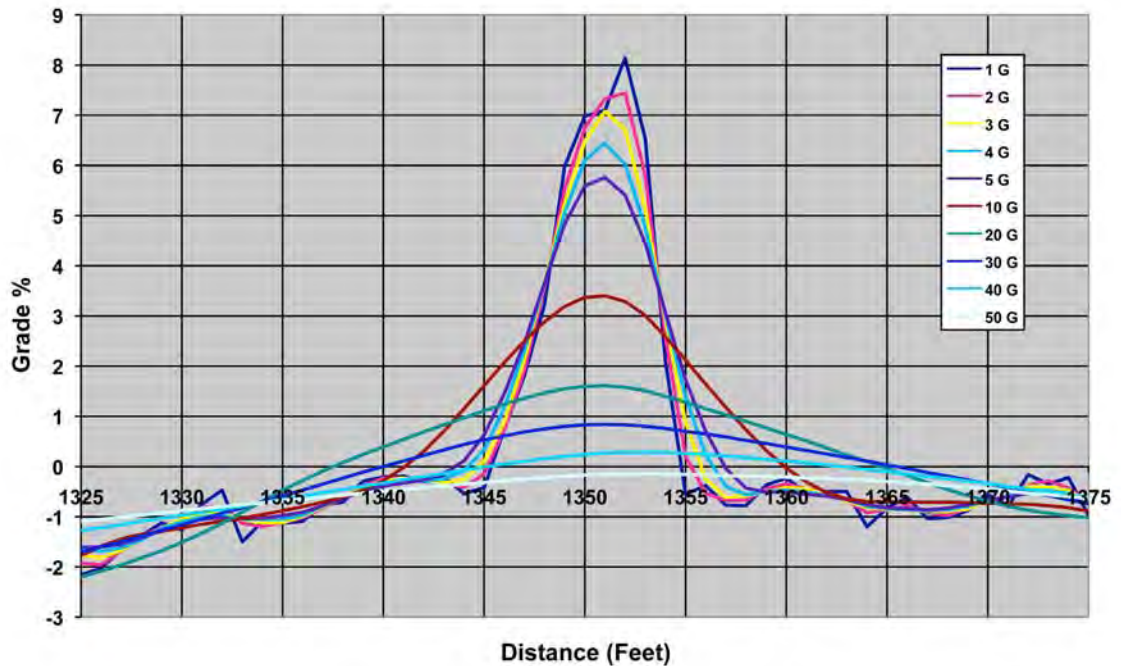

the window size (travel length for computing representative measurement) for data processing was a critical first step in arriving at these site specific calculations.

```

0807160948r.MGD - Holepad
File Edit Format View Help
Travel Marker
Dist_Ft Vst_Ft Time(s) Grade% xSlopeK yaw(deg) Casename
0.0 0.0 0.00 0.07 -1.87 0.00 0807160948r
5.0 5.0 1.26 0.58 -1.72 -2.61 0807160948r
10.0 10.0 2.50 1.18 -2.87 -5.05 0807160948r
15.0 15.0 3.50 1.80 -2.11 -5.01 0807160948r
20.0 20.0 4.30 1.80 -1.55 -4.32 0807160948r
25.0 25.0 4.99 1.62 -0.99 -4.03 0807160948r
30.0 30.0 5.60 1.57 -0.07 -3.53 0807160948r
35.0 35.0 6.17 1.62 0.59 -3.36 0807160948r
40.0 40.0 6.71 1.72 0.64 0.14 0807160948r
45.0 45.0 7.25 2.96 1.00 0.59 0807160948r
50.0 50.0 7.76 3.94 1.43 0.57 0807160948r
55.0 55.0 8.27 4.15 1.85 0.52 0807160948r
60.0 60.0 8.77 4.53 2.14 0.46 0807160948r
65.0 65.0 9.25 5.32 2.53 0.29 0807160948r
70.0 70.0 9.72 5.70 2.55 0.44 0807160948r
75.0 75.0 10.19 5.82 2.08 0.37 0807160948r
80.0 80.0 10.65 5.72 1.48 1.38 0807160948r
85.0 85.0 11.11 5.51 0.97 1.39 0807160948r
90.0 90.0 11.56 5.34 0.59 1.79 0807160948r
95.0 95.0 12.00 4.58 0.69 2.14 0807160948r
100.0 100.0 12.44 4.74 0.71 2.40 0807160948r
105.0 105.0 12.87 5.24 0.77 2.44 0807160948r
110.0 110.0 13.30 5.19 0.25 2.42 0807160948r
115.0 115.0 13.73 4.98 -0.68 2.69 0807160948r
120.0 120.0 14.15 5.21 -1.67 2.82 0807160948r
125.0 125.0 14.57 5.22 -2.08 3.46 0807160948r
130.0 130.0 15.00 5.70 -2.10 3.56 0807160948r
135.0 135.0 15.42 6.20 -2.94 2.60 0807160948r
140.0 140.0 15.84 6.67 -3.50 1.34 0807160948r
145.0 145.0 16.26 7.23 -3.52 1.19 0807160948r
150.0 150.0 16.68 7.74 -4.36 1.15 0807160948r
155.0 155.0 17.10 7.67 -3.89 1.55 0807160948r
    
```

Representative ASCII text file from ULIP data acquisition that is processed and integrated into City's GIS mapping.

In the ULIP geometry equation, the user specifies the grade and cross slope window size in feet to be applied in a moving average computation. Superimposed in the graphic above are the resulting grade ranges that correspond to ten window sizes. The graphic illustrates the effects that different grade windows have on data output values. As indicated, the most pronounced sidewalk profile values are noted when the window size is at the 1 or 2 ft ranges. In this test site, we see that with a 1 or 2 ft window size the grade value approaches 8%. The larger the window size value, the more dampened out the features of the sidewalk profile. So, at a 50 foot window size we see this test site appears to have a flat grade profile.

Guidance in defining the window size over which to assess the data was found in *Designing Sidewalks and Trails for Access* (FHWA, 1999). This report advises that grade and cross-slope "should be measured over 2 ft intervals, the approximate length of a wheelchair wheelbase, or a single walking pace." Adherence to Federal Highway Administration interpretation of features in the data set provided quality assurance in the attribute accuracy of the resulting database.

Project Approach



Once the field data collection and validity checks were performed, it was necessary for the raw data to be processed so it could be stored in the City's centralized GIS database for analysis and reporting. To facilitate this conversion of data, Bellevue staff created Python scripts and tools which use linear referencing to process ULIP raw data into a useful GIS form. Automating the process with scripts and custom interfaces was important both to limit manual efforts and to allow for daily review of data.

GIS played a pivotal role in the project from data acquisition (organizing the millions of data points generated during the study) to creating a web-based mapping interface for asset management and compliance monitoring. The resulting ADA sidewalk and curb ramp self evaluation is documented on the City's intranet. This internal web interface maps all non-standard data points related to curb ramp location and compliance rating - at the block face level, including sidewalk obstructions, heaving, running slope, and cross slope. Additional functionality of this geospatial database includes the ability to search and/or turn off certain barrier types and generate reports of the barrier information.

The ADA viewer interface creates a platform from which city staff will retrieve information on ADA barriers in the public right of way, informing the following accessibility programs:

- New Development:
New development or redevelopment projects must include sidewalks and curb ramps.
- Citizen Request Program:
Citizens submit requests to have a new curb ramp installed or have an existing curb ramp repaired at any location within the City.
- Annual Installation, Repair, and Maintenance Program:
The City's Transportation Department repairs sidewalks and installs new curb ramps annually as part of routine maintenance.

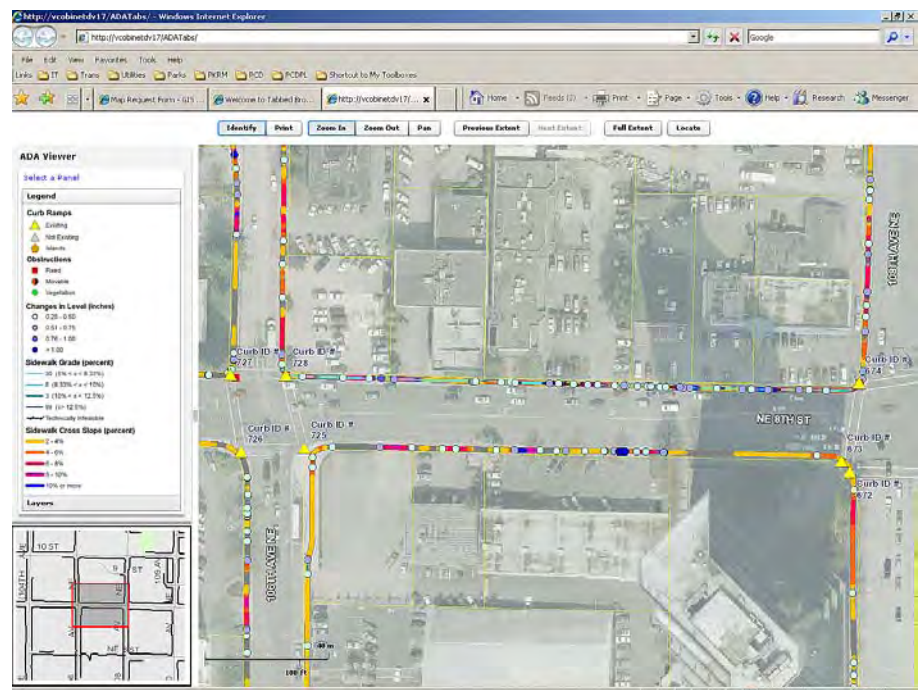

City of Bellevue's web-based ADA mapping viewer interface



ADA Self-Evaluation Report

Representative sidewalk block face report generated from the ADA viewer interface.

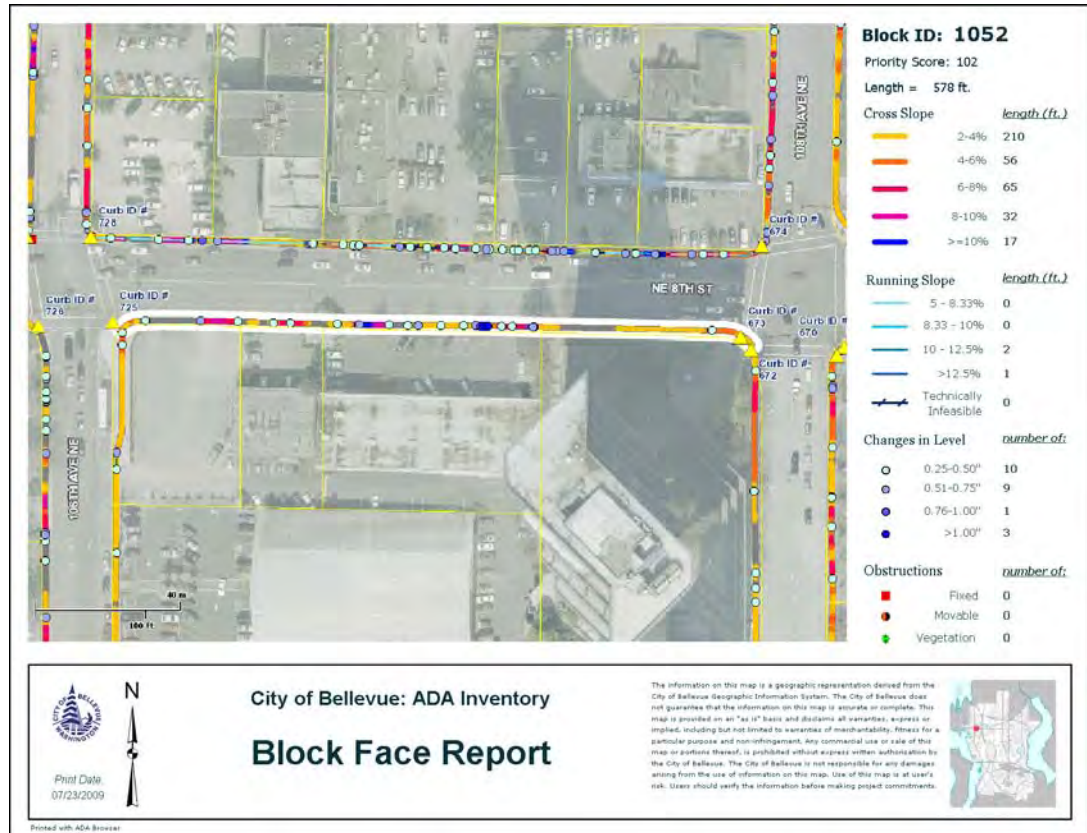

Representative curb ramp report generated from the ADA viewer interface.

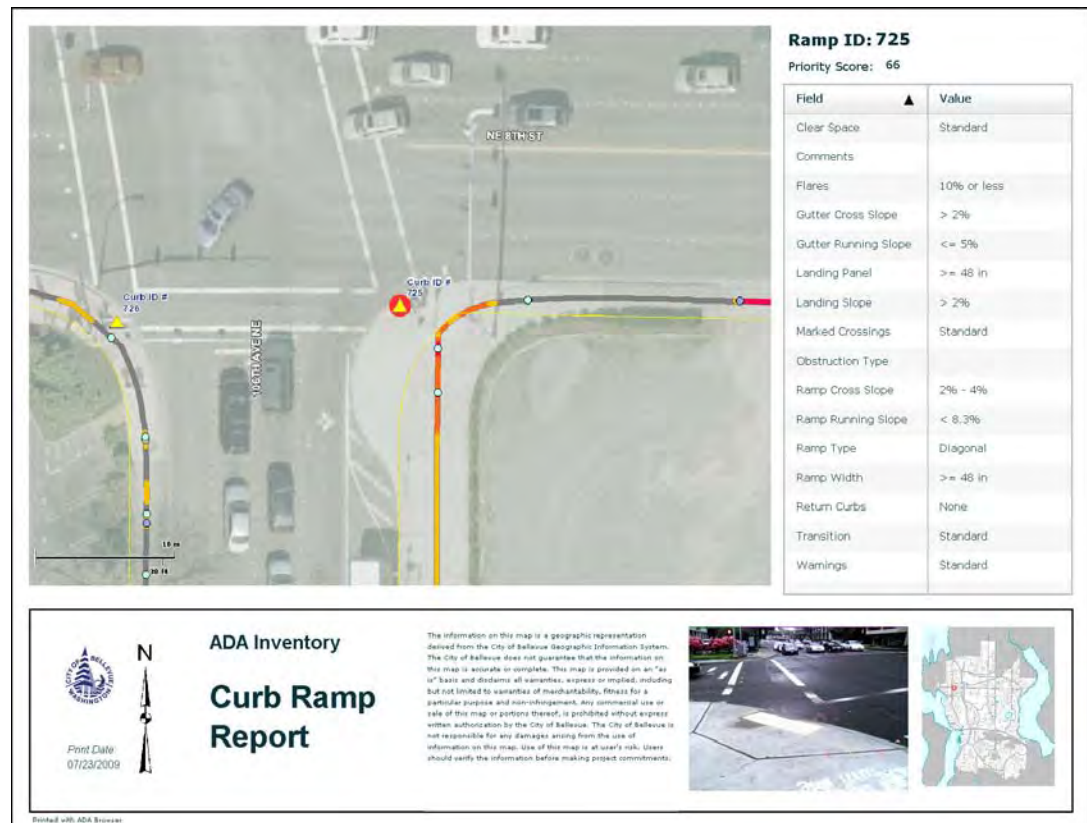

Project Approach



- Street-Related Capital Improvement Projects: Sidewalks and/or curb ramps are installed and/or repaired in all street-related capital improvement projects (e.g., street widening or other street upgrades).
- Overlay Construction Projects: The City includes the installation of curb ramps as part of street overlay projects.
- Sidewalk Maintenance and Repair Program: Streets Division personnel clear vegetation and debris from sidewalks adjacent to arterial streets, inspect sidewalks for damage, and when needed, repair walkways.

The ADA viewer and the barrier ranking results are the primary products of the ADA self-evaluation process. The technical appendix report includes 50 map sheets depicting the results of the City's barrier ranking analysis.

Phase 3. Barrier Ranking

The GIS-based barrier ranking analysis results in a combined activity and impedance score for every sidewalk and curb ramp in Bellevue. A high activity score is representative of areas where pedestrian activity (especially among persons with disabilities) is likely to be greatest, based on demographic, land use, and transportation conditions. A high impedance score is representative of areas where the quality of existing pedestrian infrastructure is poor for persons with disabilities, based on barriers documented in the sidewalk and curb ramp inventory. The key principle here is to assign a high ranking on a needs basis, not necessarily to the sidewalks and curb ramps in the worst condition but rather to those that would provide the most benefits to people with disabilities.



Activity Score – The closer that needed accessibility improvements are located to various important trip generators and transportation facilities, the higher their score. Activity factors that describe the likelihood of disability community usage of an area's pedestrian facilities are based on the following ten activity score categories (summing to a possible 100 points).



ADA Self-Evaluation Report

(i) **Locations with higher concentrations of persons with disabilities.** In Bellevue, there are an estimated 1,700 registered Access paratransit customers who, along with other Access clients in the region, take an estimated 10,000 monthly trips on paratransit services in Bellevue. This activity score category is informed by the proximity (expressed in linear feet) to home address locations of Metro Accessible services clients.

Weight	Indicator	Rating Value	
25	0-660	100%	 <p>Without Metro Access service many residents would be homebound.</p>
	661-1320	70%	
	1321-1980	40%	
	1981-2640	10%	
	2641+	0%	

(ii) **Higher volume streets.** Arterial streets are the major thoroughfares in the City's transportation system and provide area access to many destinations such as shopping centers, employment centers, and medical facilities. This activity score category is informed by Bellevue's roadway arterial classifications.

Weight	Indicator	Rating Value	
10	Major	100%	 <p>Accommodations along higher traffic volume streets increases pedestrian comfort.</p>
	Minor	50%	
	Collector	10%	
	Local	0%	

(iii) **Places of public accommodation.** The ADA emphasizes the importance of "walkways serving local government offices and facilities" as such, these locations, along with community centers, social service providers, libraries, and hospitals are prioritized. This activity score category is informed by the proximity (expressed in linear feet) to these destinations.

Weight	Indicator	Rating Value	
10	0-660	100%	 <p>Close-by destinations with connecting sidewalk facilities are convenient for all pedestrians.</p>
	661-1320	70%	
	1321-1980	40%	
	1981-2640	10%	
	2641+	0%	

Project Approach



- (iv) **Housing density.** Higher density communities with mixed land-use patterns tend to have higher levels of pedestrian activity. This activity score category is informed by Comprehensive Land Use Plan densities (expressed as units/acre).

<p><i>Pedestrians are attracted to areas where there is a good balance between housing and commerce.</i></p> 	Weight	Indicator	Rating Value
	10	MF to 30 units/acre	100%
		MF to 20 units/acre	80%
		MF to 10 units/acre	60%
		SF to 7.5 units/acre	40%
		SF to 5 units/acre	20%
		SF to 3.5 units/acre	10%
SF to 1.8 units/acre		0%	

- (v) **Seniors.** Although aging itself is not a disability, according to the U.S. Census, reported disability increases with age. This activity score category is informed by zones identified in the Census 2000 database as having 6+ percent of the population aged 65 or older.

<p><i>Although not all older adults have disabilities, those who do benefit from accessible designs.</i></p> 	Weight	Indicator	Rating Value
	10	31+	100%
		26-30	80%
		21-25	60%
		16-20	40%
		11-15	20%
		6-10	10%
0-5		0%	

- (vi) **Transit.** Dependable, accessible public transportation is especially important for people with disabilities, many of whom rely on it to get to work and actively participate in their communities. This activity score category is informed by King County Metro's 2008 stop-level boarding activity data.

<p><i>Transit provides individuals with disabilities improved access to the many amenities the community offers.</i></p>  <p>Photo: Sound Transit</p>	Weight	Indicator	Rating Value
	10	25+ boardings	100%
		11-24 boardings	50%
		1-10 boardings	20%
0 boardings		0%	



ADA Self-Evaluation Report

(vii) Employment Centers. People with disabilities have a high level of unemployment: 30 percent are not employed -- the same percentage as when the Americans with Disabilities Act became law. Removing physical barriers to employment for people with disabilities is a priority of this activity score category, informed by whether a pedestrian facility is within a major employment center identified in the Bellevue Comprehensive Plan.

Weight	Indicator	Rating Value
10	In Center	100%
	Not in Center	0%



Facilitating access to job sites improves the economic self-sufficiency of people with disabilities.

(viii) Park Facilities. There are almost 100 parks in Bellevue, with a broad range of amenities and features, including indoor pools, lakefront beaches, community centers, golf courses, skate plazas, nature trails, indoor tennis courts, and a boat launch. The City is committed to providing access to its parks, recreational facilities, and programs, for people with disabilities. This activity score category is informed by the proximity (expressed in linear feet) to these destinations.

Weight	Indicator	Rating Value
5	0-660	100%
	661-1320	70%
	1321-1980	40%
	1981-2640	10%
	2641+	0%



Offering an assortment of parks facilities provides opportunities for a variety of recreation activities.

(ix) Schools. Parents often consider “good” schools as an important factor when buying a new home. How their children get to and from school is part of that calculus. The City is committed to working with the Bellevue School District to increase the number of children who walk to school safely. This activity score category is informed by the proximity (expressed in linear feet) to these destinations.

Project Approach



<p><i>Sidewalks along public streets fronting schools serve as critical links in the transportation network</i></p> 	Weight	Indicator	Rating Value
	5	0-660	100%
		661-1320	70%
		1321-1980	40%
		1981-2640	10%
2641+		0%	

- (x) **Retail.** Removing barriers to retail establishments facilitates equality of opportunity and full participation in civic life for people with disabilities. This activity score category is informed by the proximity (expressed in linear feet) to these destinations.

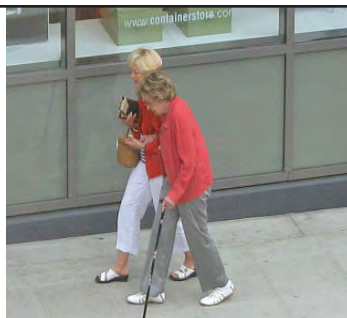
<p><i>Barrier-free retail areas allow people with disabilities to integrate with the wider community.</i></p> 	Weight	Indicator	Rating Value
	5	0-660	100%
		661-1320	70%
		1321-1980	40%
		1981-2640	10%
2641+		0%	

Impedance Score – Activity scores generated from the barrier ranking analysis are then merged with sidewalk and curb ramp impedance scores representing constraints on mobility in the public rights-of-way. The impedance score calculations are informed by design guidance found in the ADA Accessibility Guidelines (ADAAG) on dimensions and details for new construction and alterations of both sidewalks and curb ramps.

Sidewalk Impedance Score. Focuses on sidewalk characteristics that directly affect the usability of a sidewalk and determines whether the facility’s features represent a low, medium, or high barrier to accessibility. The score is based on the number and severity of incidents of each of the following barriers over a given block face: fixed obstructions, changes in level, cross-slope, and running slope. Scores are further adjusted by the ratio of non-standard features relative to the total length of the block face (a possible 100 points).

- (i) **Fixed Obstructions.** Obstructions and protrusions in the pedestrian environment are defined as objects that limit the vertical and horizontal passage space, protrude into the circulation route, or reduce the clearance width of the sidewalk. ADAAG 4.3.3 states that a minimum clear width of 36 inches be preserved in the sidewalk area. And, ADAAG 4.4 states that objects



ADA Self-Evaluation Report

projecting from walls that have leading edges between 27" and 80" should not protrude more than 4" into walks and passageways. Freestanding objects mounted on posts or pylon may overhang a maximum of 12" from 27" to 80" above the ground.

Value	Weight	Calculation
100	25	$((\# \text{ Incidents} * 100) * \text{Value}) / \text{Total Block Length} * \text{Weight}$



Utility pole obstruction at 116th Avenue NE & NE 20th Street.

- (ii) **Changes in Level.** Changes in level are defined as vertical height transitions between adjacent surfaces or along the surface of a path. Federal accessibility standards (ADAAG 4.5.2) permit changes in level less than 0.25" high to be vertical but require changes in level between 0.25" and 0.50" to have a maximum bevel of 50 percent. A ramp is required for changes in level that exceed 0.50".

Impedance Category	Value	Weight (%)	Calculation
1/4" - 1/2"	5	25	$((\# \text{ Incidents} * 10) * \text{Value}) / \text{Total Block Length} * \text{Weight}$
1/2" - 3/4"	10		
3/4" - 1"	80		
1" +	100		



Change in sidewalk level (2 inch) at 148th Avenue NE & NE 35th Street.

- (iii) **Cross Slope.** Cross slope is defined as the slope measured perpendicular to the direction of travel. Changes in cross slope are commonly found at driveway crossings without level landings. Steep cross slopes can make it difficult for wheelchair or crutch users to maintain lateral balance and can cause walkers and wheelchairs to veer downhill or into the street. ADAAG 4.3.7 does not permit cross slopes to exceed 2%.

Impedance Category	Value	Weight (%)	Calculation
2% - 4%	5	25	$((\text{Linear Feet} * \text{Value}) / \text{Total Block Length}) * \text{Weight}$
4.1% - 6%	10		
6.1% - 8%	25		
8.1% - 10%	50		
10.1% +	100		



Example of 18 percent cross slope at NE 24th Street & 167th Avenue NE.

Project Approach



(iv) **Running Slope (Grade).** Grade is defined as the slope parallel to the direction of travel. Both powered and manual wheelchairs can become unstable and/or difficult to control on sloped surfaces. ADAAG 4.8 specifies that any sidewalk that is greater than 5 percent is considered a ramp. Allowances are made to permit the grade of the sidewalk to be consistent with the grade of adjacent roadways.

<p>Example of 22 percent grade at 166th Avenue SE between Phillips Road & SE 39th Place.</p>		Impedance Category	Value	Weight (%)	Calculation
		5% - 8.33%	5	25	(((Linear Feet * Value) / Total Block Length) * Weight)
		8.34% - 10%	10		
		10.1% - 12.5%	50		
12.6% +	100				

Curb Ramp Impedance Score. Focuses on curb ramp characteristics that directly affect the usability of a ramp and determines whether the facility's features represent a low, medium, or high barrier to accessibility. The curb ramp impedance score is determined by two levels of consideration – locations where curb ramps are warranted but missing (priority 1); or, locations where curb ramps exist but have non-standard features (priority 2).

<p>Curb ramps provide critical access between the sidewalk and the street for people with mobility impairments. Without curb ramps, people who use wheelchairs cannot access the sidewalk; as such, priority 1 ramp locations receive 100 points on their impedance score</p>		Weight	Indicator	Rating Value
		100	None	100%

Existing curb ramps with non-standard features (priority 2 locations) mean that: (a) the ramp width is too narrow; (b) the top landing is either missing or too narrow; (c) the ramp slope is too steep; etc. Impedance factors that describe the barriers to accessibility at priority 2 ramp locations are based on the following twelve factors (a possible 100 points):



ADA Self-Evaluation Report

- (i) **Ramp Surface Obstructions.** Space is needed at the top and bottom of ramps so that people using wheelchairs can align with the running slope and maneuver from ramps, including when making turns (which is difficult on sloped surfaces). ADAAG 4.7.8 defines obstructions in the pedestrian environment as objects that limit the vertical passage space, protrude into the circulation route, or reduce the clearance width of the curb ramp.

Weight	Indicator	Rating Value
10	No Obstruction	0%
	Obstruction	100%



Obstruction in ramp landing panel at SE 36th Street & Factoria Boulevard SE.

- (ii) **Alignment with Marked Crosswalks.** Crosswalks are a critical part of the pedestrian network. A crosswalk is defined as “the portion of a roadway designated for pedestrians to use in crossing the street” and may be either marked or unmarked (ITE). ADAAG 4.7.9 specifies that curb ramps at marked crossings shall be wholly contained within the markings, excluding any flared sides.

Weight	Indicator	Rating Value
10	Aligned	0%
	Not Aligned	100%



Ramp not aligned with crosswalk at Main Street & 164th Avenue NE.

- (iii) **Detectable Warning Surface (DWS).** Raised tactile surfaces used as warnings employ textures detectable with the touch of a foot or sweep of a cane to indicate hazards or changes in the pedestrian environment. ADAAG 4.29 specifies that tactile surfaces used as detectable warnings must also provide color contrast with surrounding surface materials.

Weight	Indicator	Rating Value
10	Standard DWS	0%
	Non-Standard DWS	100%



Non-standard detectable warning surface at SE 34th Street & 111th Avenue SE.

Project Approach



(iv) **Smooth Gutter/Ramp Transition.** Vertical changes that exceed 1/4 inch in elevation at the bottom of a ramp can cause front casters to swivel and impede the momentum needed to propel the chair up-slope at a curb ramp threshold. ADAAG 4.7.2 specifies that transitions from ramps to gutter and streets should be flush and free of level changes.

Gutter/ramp transition not smooth at SE 26th Street & 130th Avenue SE.



Weight	Indicator	Rating Value
10	Smooth Transition	0%
	Lacking Smooth Transition	100%

(v) **Landing Panel Size.** Landings allow wheelchair users space to maneuver off the curb ramp and onto the sidewalk. Curb ramps without landings force wheelchair users entering the ramp from the street, as well as people turning the corner, to travel on the ramp flares. Furthermore, people who are continuing along the sidewalk will not have to negotiate a surface with a changing grade or cross slope. ADAAG 4.8.4 specifies that landings with a minimum length of 48 inches, the length of an occupied wheelchair, will provide sufficient turning space. Landing length is measured in the direction of travel to and from the ramp. Landings should be a minimum of 36 inches wide (48 inches is preferred) to prevent pedestrians from having to cross the curb ramp flare. If ramps change direction at landings, commonly known as parallel ramps, the minimum landing size should be 60 inches by 60 inches. This additional space helps avoid trapping the footrest of a wheelchair between opposing up-slopes.

Ramp landing panel missing at 126th Avenue NE & NE 9th Street.



Weight	Indicator	Rating Value
10	≥ 48"	0%
	36-47"	40%
	< 36"	60%
	None	100%



ADA Self-Evaluation Report

(vi) Landing Panel Slope. Level landings at the tops of curb ramps make it possible to change direction after completing the ascent, rather than during the rise, and to avoid traveling across the compound slope of a side flare when using the sidewalk rather than the curb ramp. ADAAG 4.8.4 specifies that ramps shall have level landings at bottom and top of each ramp and each ramp run. Landings are considered “level” when their slopes in the two perpendicular directions of travel do not exceed 2%.

Weight	Indicator	Rating Value
5	≤ 2%	0%
	> 2.1%	100%



Steep ramp landing panel slope at SE 56th Street & 175th Place SE.

(vii) Ramp Width. The recommended minimum curb ramp width is 48 inches. Where space is restricted, the width of the ramp can be reduced to 36 inches. ADAAG 4.7.3 specifies that the curb ramp width should never be less than 36 inches (exclusive of flared sides) because there is not enough space for people using assistive devices (e.g., wheelchairs, scooters, and crutches) to travel.

Weight	Indicator	Rating Value
10	≥ 48"	0%
	36-47"	50%
	< 36"	100%

(viii) Ramp Flare Slope. The flared sides of curb ramps provide a graded transition between the ramp and the surrounding sidewalk. Flares are not considered an accessible path of travel because they are generally steeper than the ramp and often feature significant cross-slopes with excessive rate of change of cross-slope. ADAAG 4.7.5 specifies that a 10 percent flare slope is acceptable.

Weight	Indicator	Rating Value
5	≤ 10%	0%
	10.1% - 12%	50%
	> 12.1%	100%



Steep ramp flare slope at Main Street & 100th Ave SE.

Project Approach



(ix) **Ramp Panel Running Slope (Grade).** The ramp panel running slope is the sloped transition between the street and the sidewalk. Steep grades are difficult for people who use walking aids and manual wheelchairs to negotiate because more energy is needed to begin and to travel on sloped surfaces. ADAAG 4.8.2 specifies that the ramp panel running slope should not exceed 8.33%.

<p><i>Steep ramp panel running slope at 109th Avenue NE & NE 9th Street.</i></p> 	Weight	Indicator	Rating Value
	10	< 8.33%	0%
		8.34% - 10%	50%
> 10.1%		100%	

(x) **Ramp Panel Cross Slope.** A curb ramp allows people who use wheelchairs and other wheeled devices to negotiate the elevation change between the roadway and the sidewalk without having to negotiate the curb. People with mobility impairments often have difficulty negotiating a grade and cross slope simultaneously. Since the grade of the ramp will be significant, the cross slope should be minimized. ADAAG 4.8.6 specifies that ramp panel cross slopes should not exceed 2%.

<p><i>Steep ramp panel cross-slope at 128th Avenue SE & SE 32nd Street.</i></p> 	Weight	Indicator	Rating Value
	10	≤ 2%	0%
		2.1 - 4%	50%
> 4%		100%	

(xi) **Gutter Running Slope (Grade).** The gutter is the roadway surface immediately next to the curb ramp that runs along the curb. At a curb ramp, the grade of the gutter is generally counter to the grade of the ramp. Excessive grade differences between gutter and ramp can cause a wheelchair to tip forward or flip over backward. According to ADAAG 4.7.2, the running slope of the gutter – measured parallel to the path of travel – should not exceed 5 percent. If the gutter running slope exceeds 5 percent, the rate of change of grade is likely to exceed 13 percent, depending upon the grade of the ramp.



ADA Self-Evaluation Report

Weight	Indicator	Rating Value
5	≤ 5%	0%
	> 5%	100%



Steep gutter running slope at SE 26th Street & 130th Avenue SE.

(xii) Gutter Cross Slope. People with mobility impairments often have difficulty negotiating a grade and cross slope simultaneously. Since the grade of the ramp and gutter will be significant, the cross slope of both the ramp and gutter should be minimized. ADAAG 4.8.6 specifies that gutter cross slopes should not exceed 2%.

Weight	Indicator	Rating Value
5	≤ 2%	0%
	> 2%	100%

Disability Community Participation

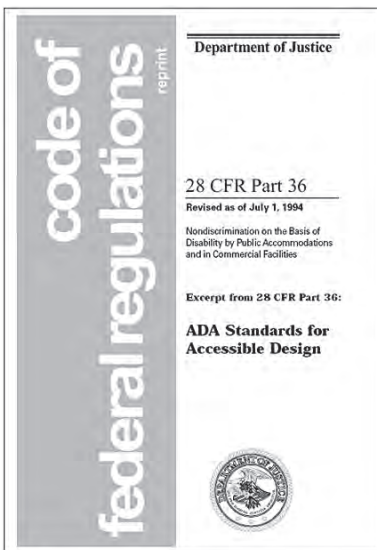

ADAAG tells us which features in the public rights of way are non-standard but it does not tell us which of these non-standard features should be replaced first.

An effective ADA Self-Evaluation Report and Transition Plan process requires that the City of Bellevue remove barriers at sidewalk and curb ramp locations that provide most benefits in return. To achieve this goal, the point values assigned to the various non-standard features in the impedance calculation described above arose from consultations with members of the disability community in Bellevue. Through an open house, survey, focus groups, and site visits in the field, Bellevue staff learned which non-standard features should be replaced first.

Bellevue's approach to community engagement is consistent with ADA Title II guidance requiring governmental entities to: (i) Provide opportunity to interested persons and groups to participate in self-evaluation leading to transition plan. 28 C.F.R. § 35.105(b); and, (ii) Make self-evaluation and plan available for public inspection. 28 C.F.R. § 35.105(c).

The following two thematic points were raised by Bellevue residents and their specific comments:

Project Approach



Theme 1: It is apparent that Bellevue is striving to provide accessibility features and elements in sidewalks and at curb ramp locations.

- “The devices that have been added have helped me with broadening my horizons, broadening my scope of where to go, how to get from point A to point B, finding easier ways, and knowing that there may not be an easy way in this area, but if I go a few more feet, I will find some.”
- “It was very difficult for me to go anywhere just because it wasn’t accessible. Now, with these changes that are being made, it makes things much easier, much more beneficial for me to get to where I need to go without having to force my way to do anything.”
- “Nowadays you can get a power-chair and a person beside the chair on the same sidewalk, whereas ten years ago it was tough to get even a power-chair on the sidewalk because it wasn’t as wide as it is today. And the fact that it’s wider today and it’s easier to have the bigger mobility devices and the ambulatory person on the same sidewalk together increases the goal for the multi-challenged to want to get out more.”



“I hope that my input will result in the planners who are prioritizing what work is going to be done to take into account the needs and desires and wishes of people who are blind, as well as the broader disability community.”

~ Bellevue resident for 11 years

Theme 2: Some of these features and elements in the public rights of way may not meet minimum ADA requirements and specifications for accessibility, and in other cases, these features are either missing or may not be usable.

- “I’d say that Bellevue has done a pretty good job in adapting to the lay of the land as it exists. Obviously some things aren’t quite as they should be, which is why we’re talking here today. You’re trying to make that better.”
- “When I’m in my power chair I just drive where I need to go, and I don’t need to think about all the little inclines, and having a little step, or having slope. But when I’m in my walker, I really have to think about how fast I’m going.”
- “The one common problem is shrubs and hanging limbs and briars that aren’t trimmed by either the city or the property owner. A couple times a year I will go out with a little hand trimmer and trim a safe path along a couple of sidewalks that I traverse.”
- “I don’t know what the count is, but certainly the majority of intersections in Bellevue do not have audible signals. It would make life easier if major intersections did have such devices.”

Bellevue ADA Compliance Plan
Evaluation of curb ramp features
Site #1 - Ramp #1

Path of Travel • Running slopes are parallel to **Path of Travel**.
• Cross slopes are perpendicular to **Path of Travel**.

■ Landing Panel ■ Curb □ Gutter/ramp transition
□ Ramp Panel ■ Flares ■ Detectable Surface

Curb ramp feature	As-Built	ADA Standard	Impact on use of ramp?		
			Low	Medium	High
Ramp Running Slope	12%	8.3% max	Low	Medium	High
Ramp Cross Slope	1.9%	2% max	Low	Medium	High
Ramp width	36"	36" min	Low	Medium	High
Detectable warnings	No	Yes	Low	Medium	High
Gutter/ramp transition	Smooth	Smooth	Low	Medium	High
Landing panel size	36" x 48"	36" x 48" min	Low	Medium	High
Landing panel slope	1.8%	2% max	Low	Medium	High
Gutter Running Slope	0.8%	5% max	Low	Medium	High
Gutter Cross Slope	2.7%	5% max	Low	Medium	High
Flare slope	10.6%	10% max	Low	Medium	High

Curb ramp assessment form used with disability community on site visits in the field.



ADA Self-Evaluation Report

22) Please share accessibility difficulties or convenience along pedestrian routes you normally take.

Street Name/Cross Street: NE 16th Street NE 14th - NE 15th
 Comments: There is a raised sidewalk

Street Name/Cross Street: NE 8th Street NE 10th - NE 11th
 Comments: There is a ramp on the side of the road that is not marked with a sign. It is a ramp to the sidewalk.

23) Describe the most important action the city can take to increase accessibility of its facilities, program and services, and sidewalks/curb ramps.

best solution is by digging them out and having more ramps.

24) Please share other comments, expectations, recommendations related to the accessibility of Bellevue facilities, program and services, and sidewalks/curb ramps.

There are a lot of places that are not marked for a wheelchair. There are some concrete ramps.

25) Do you live in Bellevue? Yes No

26) Do you work in Bellevue or visit Bellevue more than once a week? Yes No

27) Optional: What is the nature of your disability (Select all that apply).

Visual Mobility Other Hearing Cognitive Other Speech/voice

Over 100 Bellevue residents completed mail-back ADA surveys.

- “If it’s where I’m going down the ramp and crossing, if there’s a big pole or if there’s not enough room for me to get on the side of the ramp – if there’s some kind of obstacle like a garbage can it can be an issue because I’m trying to cross and the car’s coming and I need to get on the sidewalk.”
- “From the standpoint of a blind traveler, what makes a lot more difference than many of the things on the ADA list is the orientation of the ramp. When I’m traveling I assume I’m going straight down the sidewalk and my dog takes me to the ramp and to the bottom, that I’m in the crosswalk and I am aimed in the right direction to cross to the other crosswalk. I suspect there are times when those last two things aren’t true, and places that are not like that are a problem. Because the dog or a person with a cane has to be trained that that’s an unusual crossing. I use the sound of traffic to judge where I am, but I presume the crosswalk is targeted at the other crosswalk and that the other up-curb is in the crosswalk.”
- “As far as sidewalks, the issues are raised sidewalks, from tree roots – you have to learn where those are and to expect them, and then property owners or the city cause problems when they don’t trim. Especially these blackberry vines that can reach out and grab you. When they come out over the sidewalk or tangle down from trees, those are real issues.”
- “Sometimes the curbs aren’t sloped, so what I have to do is take my walker and lift it up onto the curb. Sometimes that’s difficult to do.”



SIDEWALK BARRIERS

What should we fix first?

Place a dot next to that photo.

<p>Narrow </p>	<p>Missing </p>
<p>Broken </p>	<p>Vertical Separation </p>
<p>Utility Pole Obstruction </p>	<p>Car Obstruction </p>
<p>Basketball Hoop Obstruction </p>	<p>Encroaching Vegetation </p>
<p>Sidewalk Running Slope </p>	<p>Sidewalk Cross Slope </p>
<p>Driveway Running Slope </p>	<p>Driveway Cross Slope </p>

One of the posters used at an open house

Sidewalk Inventory



This section of the ADA Self-Evaluation Report assesses the accessibility of Bellevue's sidewalk network. Accessible sidewalks enable people with disabilities to reach their desired destinations in the community and to enjoy the benefits of city services, programs, and activities. Where sidewalks are provided, public agencies are required to ensure that continuous, unobstructed sidewalks are maintained in operable working condition.

Ever since the ADA passed, the court system has heard a steady stream of cases interpreting its provisions. On January 22, 2004, the court granted final approval of the settlement in *Barden v. Sacramento*. Prior to the *Barden* decision, it was commonly understood that the minimum requirement for achieving program accessibility, in an existing public right-of-way that is not otherwise being altered, is the installation of curb ramps at locations where existing pedestrian walkways cross curbs. The court decision in the *Barden* case relied upon the language in the ADA regulations that requires city ADA Transition Plans to include a schedule for the installation of curb ramps at intersections, holding that this requirement would be "meaningless if the sidewalks between curb ramps were inaccessible."

The *Barden* decision means that public entities, such as the City of Bellevue, are required to invest in the repair of public sidewalks and maintain them free of barriers, physical defects and other conditions that may deny pedestrians with disabilities access to sidewalks. In this section of the ADA Self-Evaluation Report, Bellevue's sidewalk accessibility is evaluated based on the following ADAAG standards:

(i) accessible route must be 3 ft min. width; (ii) surfaces are firm, stable, and slip resistant; (iii) changes in level of no more than 1/4" unless beveled then 1/2"; (iv) max grade is 5 percent on continuous runs; (v) sidewalks adjacent to existing roadways may follow grade of roadway; and, (vi) cross slope shall not exceed 2 percent.

Obstructions

Obstructions in the pedestrian environment are defined as objects that limit the vertical and horizontal passage space, protrude into the circulation route, or reduce the clearance width of the sidewalk. ADAAG 4.3.3 states that a minimum clear width of 36" be preserved in the sidewalk area. And, ADAAG 4.4 states that objects projecting from walls that have leading edges between 27" and 80" should not protrude more than 4" into walks and passageways. Freestanding objects mounted on posts or pylons may overhang a maximum of 12" from 27" to 80" above the ground. When ADAAG standards are not observed, pedestrians can face serious obstacles.



"Some places the sidewalk looks really well put together. Other times you go next door and the sidewalk is all crumbled up. And then you go one more house down and the sidewalk is fine. So it changes. So what I do is sometimes just stay at home or I'll have Access show up and I'll get the assistance I need to get to where I want to go. Because otherwise it would be too much of a bother."

~ Bellevue resident for 20+ years



ADA Self-Evaluation Report

Obstructions come in a variety of forms, ranging from movable obstructions such as a car parked across a sidewalk or an overgrown flowerbed to more durable obstructions like utility poles, fire hydrants, or sidewalks that are too narrow to accommodate the 36" by 80" path of travel. Obstructions with large overhangs that protrude into the path of travel can be hazardous for people with visual impairments if they are difficult to detect. Obstructions that reduce the minimum clearance width, such as fire hydrants on a narrow sidewalk, can create significant barriers for wheelchair or walker users.







Hydrant on 3 foot sidewalk at Main Street & 107th Avenue NE renders sidewalk unusable to people with disabilities.

Fixed Obstructions – During the sidewalk inventory, fixed obstructions were measured as they occurred along the sidewalk and recorded on the GMS-2 handheld GPS device. The GMS-2 allowed field staff to create custom data fields that generated a database of attributes for each fixed obstruction including geospatial coordinates, the type of obstruction (narrow sidewalks, sign posts, utility poles, mailboxes, and other), any relevant notes or comments pertaining to the obstruction, and an image of the obstruction.

The inventory team found a total of 226 fixed obstructions throughout the City of Bellevue. By type, the fixed obstructions were recorded as follows:

Fixed Obstructions in Bellevue (N =226)

	Obstruction Type	Number	Percent
	Utility Poles	89	39%
	Tree Wells	75	33%
	Mailboxes	24	11%
	Other: includes ped poles, utility access, hydrants, sign posts, railings, etc.	23	10%
	Narrow Sidewalks	15	7%

Sidewalk Inventory



The map below shows the density of fixed obstructions relative to miles of sidewalk. The areas with darker shading have more obstructions per mile, while the ones with lighter shading have fewer.

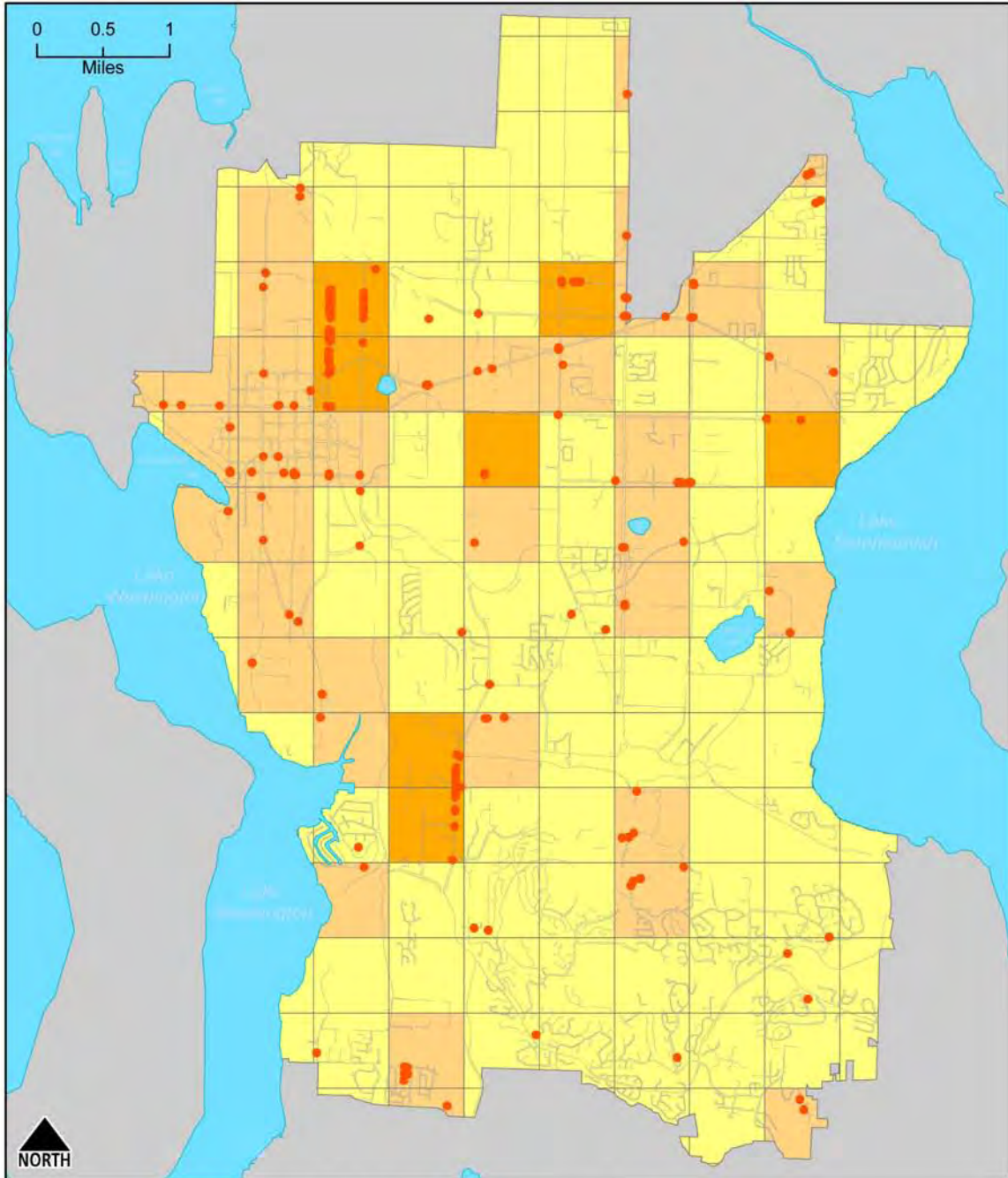

City of Bellevue ADA Sidewalk Survey Fixed Obstruction Locations and Density

Each Orange Point = One Fixed Obstruction

Fixed Obstruction Density = Fixed Obstructions / Sidewalk Length

Fixed Obstructions per Mile

0

1 - 3

4 - 21

● Fixed
obstructions
— Sidewalks



ADA Self-Evaluation Report

The City of Bellevue has implemented a number of work-around solutions to address fixed obstructions. Work-around solutions usually either relocate an obstruction or widen a small portion of the sidewalk to restore an accessible route. The examples below show work-around solutions. The top row shows an obstructing mailbox at left and a sidewalk widened to accommodate both a mailbox and an accessible route at right. The second row shows a hydrant obstructing a curb ramp at left, and a hydrant at right, located out of the pedestrian route, camouflaged by landscaping. The bottom row shows a pedestrian pole obstructing the top landing of a curb ramp at left and a pedestrian pole built into a concrete bulb out at right to accommodate both pedestrian pole access and sidewalk and landing access.



SE Cascade Key & SE Skagit Key (left); and 163rd Avenue & Lake Hills Blvd SE (right).



148th Avenue NE & Northup Way (left); and NE 15th Street & NE 15th Place (right).



Factoria Blvd SE & SE 36th Street (left); and NE 24th Street & 164th Avenue NE (right).

Sidewalk Inventory



Movable Obstructions – The difficulties presented by movable obstructions are as real as those caused by fixed obstructions. Garbage cans left out on trash day or cars parked across a sidewalk pose challenges to persons with disabilities. The photos below show a variety of movable obstructions.



Two basketball hoops obstructing sidewalk at 159th Avenue NE and NE 24th Street.



Person in wheelchair navigating on trash day at 166th Avenue SE between Phillips Rd and SE 39th Place.



Vehicles obstructing sidewalk at SE 36th Place & Somerset Place SE.



Furniture and planters at sidewalk café obstruct ramp landing and narrow the pedestrian pathway at 102nd Avenue SE & Main Street.



Wheelchair user is forced to use the gutter along SE 8th Street instead of the adjacent sidewalk because of a poorly placed garage sale sign at the curb ramp located at 143rd Avenue SE and SE 8th Street. In Bellevue, portable signs, including sandwich boards, are generally prohibited from the right-of-way. No signs shall be placed "so as to be hazardous to a...pedestrian's ingress and egress from...any way open to the public" (22B.20.140).





ADA Self-Evaluation Report

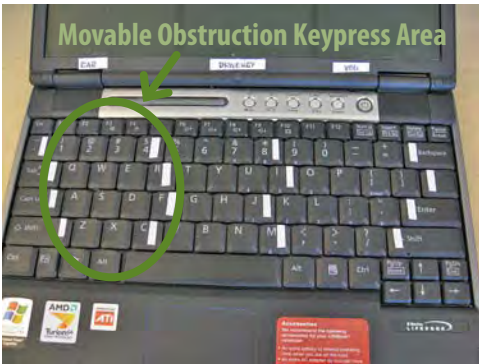

While collecting data with the ULIP, field staff pressed a key on the notebook computer in the designated area to track a movable obstruction.

The inventory team recorded 722 movable obstructions, including parked cars, trash cans, and basketball hoops throughout the City of Bellevue. While vegetation is a movable obstruction subcategory, it was not included in the movable obstruction measure.

Because the sidewalk inventory was structured to avoid trash days the figure of 722 movable obstructions is likely fewer than the reality pedestrians encounter when moving about Bellevue on a day to day basis. Weekly trash collection means that sidewalks lacking planter strips (especially the 5' wide ones) will be inaccessible to wheelchairs a minimum of 15% of the time (and this is assuming that people retrieve their cans from the sidewalk in a timely fashion, by late afternoon of trash day).

Field staff used a unique methodology for capturing data on movable obstructions. While measuring segments of sidewalk with the Segway-mounted ULIP system, field staff noted the location of obstructions by pressing a key in a designated area of their laptop keyboard. Each key-press during the course of a data collection run was recorded as part of the ULIP data files and, when mapped back in the office using GIS software, provided exact geospatial data for every movable obstruction in the city.



Parked vehicle obstructing sidewalk with rolled curb on SE 52nd Place.

Unlike the GMS-2 with manual entry, the ULIP methodology was not set up to allow field staff to record what specific object caused the obstruction. However, trash cans and parked cars seemed to be the most common movable obstructions. Field staff observed a higher incidence of obstructing parked cars in neighborhoods with rolled curbs as opposed to vertical curbs. Because motorists can easily drive over them, rolled curbs tend to encourage obstructive parking.

Parking on a sidewalk or a crosswalk is illegal under state law (RCW 46.61.570). It is also illegal under the Bellevue City Code to operate a vehicle on or across a sidewalk where a driveway does not exist (BCC 11.48.200). The Bellevue Police Department enforces parking codes in areas outside of Downtown; Diamond Parking enforces them within Downtown. In 2008, Diamond Parking wrote 8 tickets for illegally parking on the sidewalk. Outside of Downtown, the Bellevue Police Department cited about 20 drivers for this violation.

Sidewalk Inventory



The City of Bellevue can use analyses of movable obstruction density to target its outreach activities to neighborhoods where movable obstructions are a problem. The map below shows the density of movable obstructions relative to miles of sidewalk. The areas with darker shading have a higher density of movable obstructions, while those with lighter shading have fewer movable obstructions per sidewalk mile.

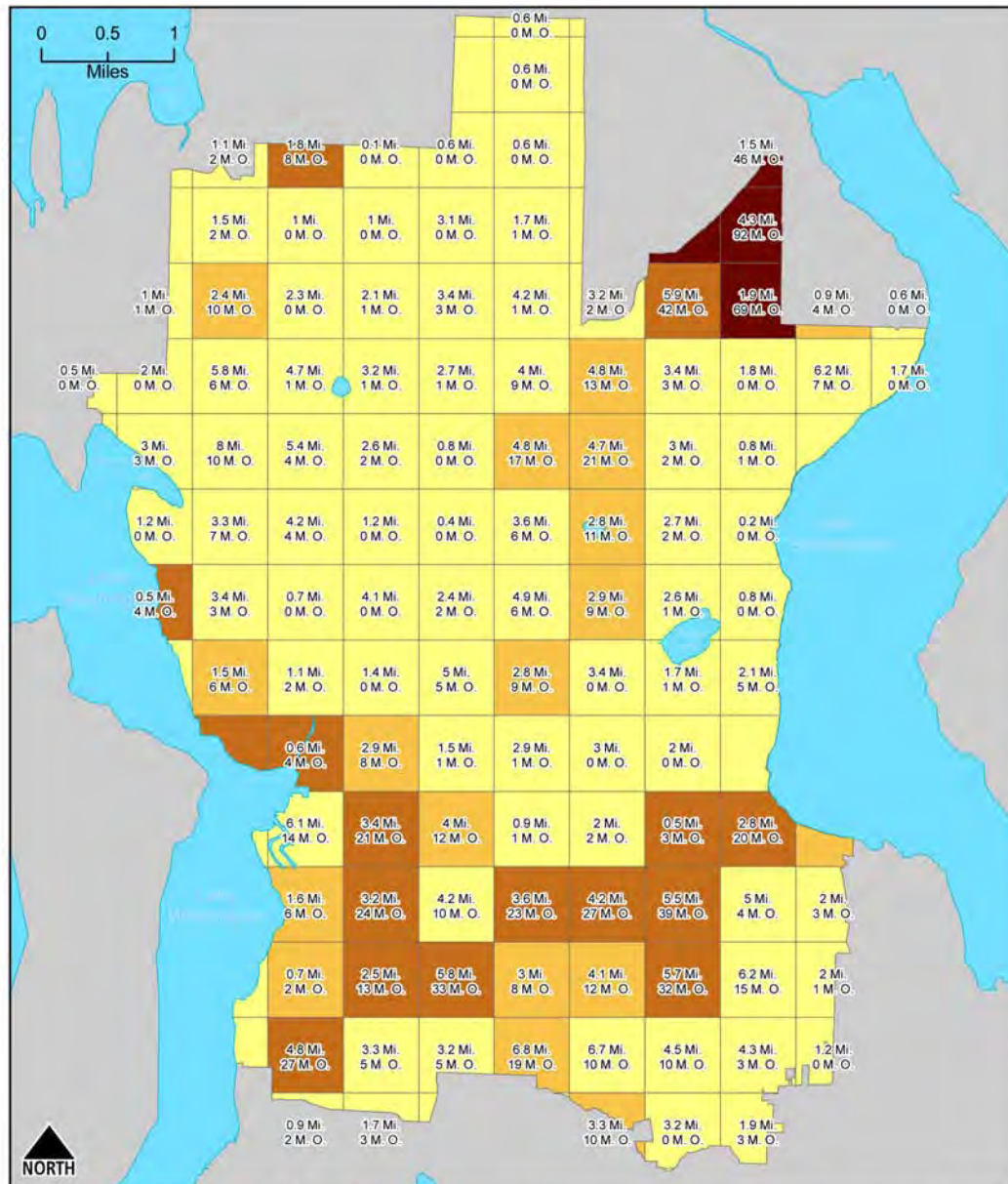

City of Bellevue ADA Sidewalk Survey Moveable Obstruction Density

Moveable Obstruction Density =

Moveable Obstructions / Sidewalk Length

Moveable Obstructions Per Mile

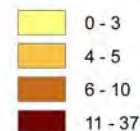



ADA Self-Evaluation Report

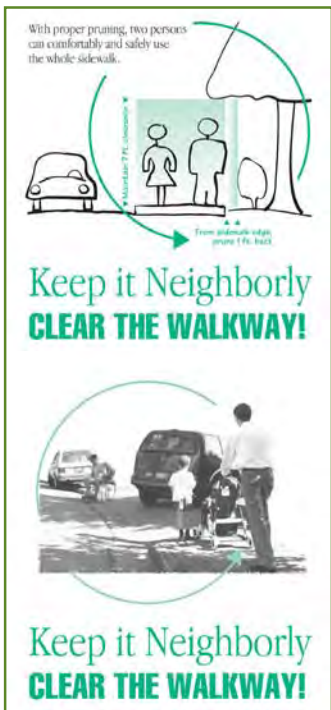

In many instances residents are unaware of the impact their trash cans, basketball hoops, and illegally parked cars have on accessibility. The City of Bellevue has in place a “Keep it Neighborly” public information campaign aimed at explaining how residents are expected to eliminate sidewalk obstructions in front of their properties.

Reminding residents to park cars in the street, rather than straddling the sidewalk is an obvious way to improve accessibility. Moving trash cans onto vegetated strips where possible, or pulling them back into driveways rather than onto sidewalks is another easy way for residents to limit obstructions. In addition, elective objects such as basketball hoops, sidewalk café furniture, or decorative planters should be restricted to yard spaces, driveways or wider spots in the sidewalk.

Removal of obstructions is a process that relies on residents and neighborhood groups as much as City government. The photographs below show obstruction situations, and alternative arrangements that leave the sidewalk free of obstacles.

Keep it Neighborly flyers are distributed to residents to educate them about the importance of maintaining a clear path of travel on city sidewalks.



Van parked illegally blocking the sidewalk on 136th Place SE (left); and, cars parked legally in the street and in the adjacent driveway at 35th Place NE & 171st Avenue NE (right).



Basketball hoops obstructing the sidewalk at 159th Avenue NE & NE 24th Street (left); and, located out of the pedestrian right-of-way in a driveway at NE 15th Street & NE 15th Place (right).



Trash cans blocking the sidewalk at SE 65th Street & Forest Drive SE (left); and, trash cans pulled into the driveway at NE 10th Place & 148th Avenue NE (right).



Mailboxes blocking the sidewalk at 21st Place SE & SE 22nd Street (left); and, re-located to the underutilized cul-de-sac island at 170th Place NE & NE 35th Street (right).

Sidewalk Inventory



Vegetation is a subcategory of movable obstruction and is by far the most common obstruction on Bellevue's pedestrian network. When bushes or tree branches force pedestrians to turn back or move into the path of automobile traffic, they present serious obstacles to accessibility. The Bellevue City Code requires property owners to trim back vegetation on their property so that it does not "obstruct or impair the free and full use of the sidewalk or street" (BCC 14.06.010). The photos below show a variety of vegetation obstructions in Bellevue.



150th Place & 45th Street SE.



SE 20th Street & 140th Avenue SE.



112th Avenue NE & NE 8th Street.



165th Place SE.



112th Avenue SE & SE Bellevue Way.



150th Place SE & SE 45th Street.

ADA Self-Evaluation Report



Wheelchair user struggles to traverse a sidewalk that has both vegetation and debris at 165th Place SE & SE 39th Place.

In addition to narrowing the pedestrian path of travel, unchecked plants drop debris. While there is no standard threshold for debris, ADAAG 4.5.1 requires that pedestrian surfaces be “stable, firm, and slip-resistant.” Downed branches, fallen conifer needles, leaves, and scattered gravel create uneven and slippery surfaces. The image at right shows debris fallen from trees on adjacent properties and the uneven conditions they create on sidewalks.

Because of seasonal and weather-based variations in debris conditions, field staff did not collect data about debris locations. However, they did observe the frequent overlap of debris and vegetation obstructions.

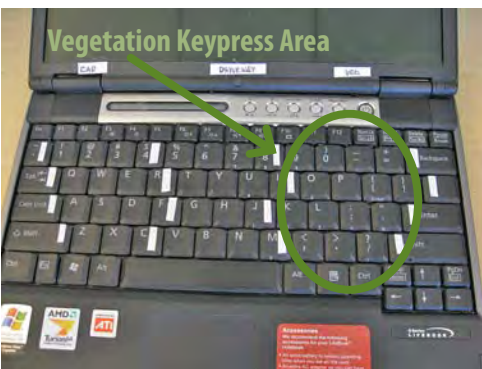

While collecting data with the ULIP, field staff pressed a key on the notebook computer in the designated area to track a vegetation obstruction.

Field staff recorded a total of 5,996 vegetative obstructions. These varied in severity from overgrown flower beds to bushes or tree limbs that completely block the pedestrian path of travel. In addition to quantitative data on vegetation, the field team observed debris problems in neighborhoods throughout the city. These problems often coincided with overgrown and untended vegetation abutting the pedestrian path of travel.

Field staff used the same methodology for recording movable obstructions and capturing data about vegetation. While measuring sidewalks on the ULIP, surveyors noted locations of obstructing vegetation by pressing a key in a designated area on the laptop keyboard. Each key-press during the course of a run was recorded as part of the ULIP data files, and was mapped using GIS software back in the office. The image at right shows the keyboard layout with the designated “vegetation” section circled.

Sidewalk Inventory



The map below shows the density of vegetative obstructions by sidewalk miles. It should be noted that the seasonal nature of vegetation obstructions means that the data is a broad indicator, rather than a reliable measure of individual instances of non-compliance.

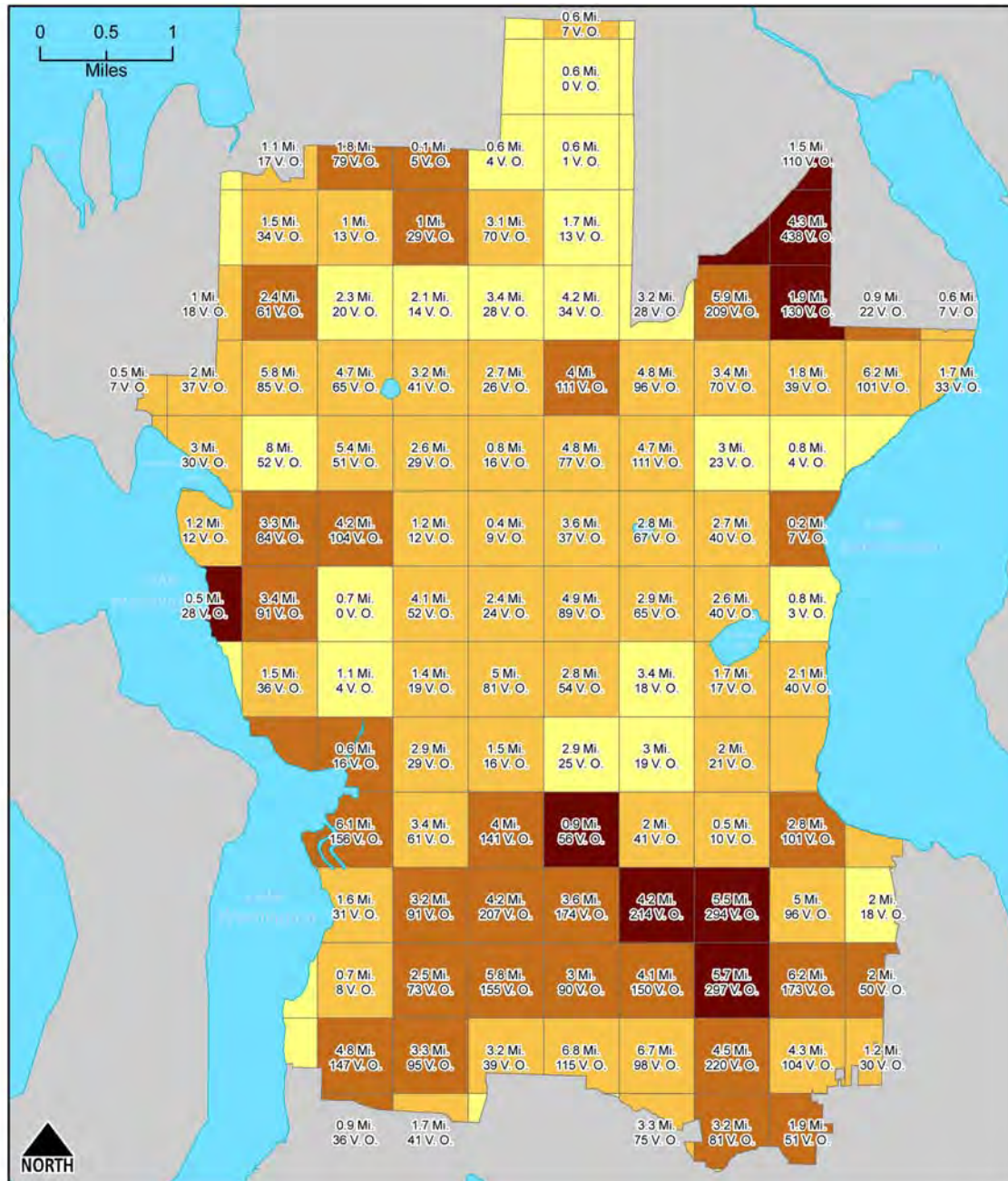

City of Bellevue ADA Sidewalk Survey Vegetation Obstruction Density

Obstruction Density = Vegetation / Sidewalk Length

Vegetation Obstructions Per Mile

- 0 - 10
- 11 - 25
- 26 - 50
- 51 - 101



ADA Self-Evaluation Report

Changes in Level



Adopted by City Council in 1966, the Bellevue Sidewalk Maintenance and Repair Program provides for regular maintenance and repair of all arterial sidewalks. Under this program, Streets Division personnel clear vegetation and debris from sidewalks adjacent to arterial streets, inspect sidewalks for damage, and when needed, repair walkways.

Changes in level are defined as vertical height transitions between adjacent surfaces or along the surface of a path. In the sidewalk environment, curbs with cracks, and dislocations in the surface material are examples of changes in level. The texture and continuity of sidewalk surfaces has a significant impact on sidewalk accessibility. People who use wheelchairs, crutches, canes, or walkers are particularly sensitive to tripping hazards. People with mobility impairments need a stable and regular surface for unimpeded access to sidewalks.

In the City of Bellevue, more than 90% of sidewalks (approximately 298 miles) are concrete and the remainder are made of asphalt and brick. When built to ADA specifications these sidewalks provide hard, stable and relatively smooth surfaces for pedestrians and people using mobility aids.

Heaving can affect all kinds of sidewalk surfaces. Concrete sidewalks are harder and whole panels (or panel pieces) tend to move as separate units, creating problems at the panel transitions where changes in level occur. Asphalt is more malleable and deforms in response to pressure. Thus, when trees roots push up under a sidewalk, asphalt tends to conform to the shape of the roots creating a situation where several rounded protrusions can disrupt ease of pedestrian movement.



Two inch change in level in a concrete sidewalk at 58th Place & SE 58th Street.



Change in level in an asphalt sidewalk at SE 27th Street & 124th Avenue SE.

Sidewalk Inventory



The guidance from ADAAG 4.5.2 on changes in level is as follows: (i) up to 0.25" - no modification required; (ii) 0.25 to 0.5 inches - bevel the surface with a maximum slope of 50 percent; and, (iii) greater than 0.5" - install a ramp with a maximum grade of 8.3 percent. Bellevue relied on its Ultra-Light Inertial Profiler (ULIP) to identify sidewalk locations with changes in level that exceed ADAAG standards using laser, accelerometer, and distance measurements. Before the final output is produced, the laser height data is first filtered to remove signals resulting from cracks/joints/gaps/grating and surface debris. Then the software searches for non-standard sidewalk faults (heaving) and transitions (bevels). Finally the software produces a file compatible with the city's computerized mapping system.

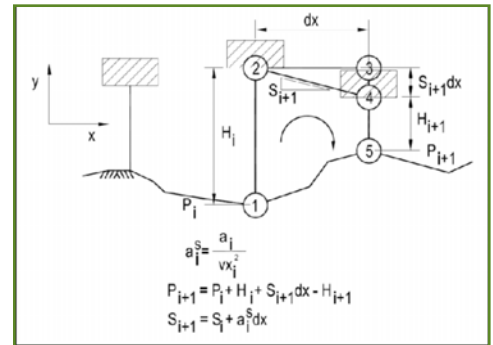

ULIP data processing equation for calculating sidewalk changes in level.

Field verifying ULIP results supported the city's QA/QC protocol and assisted in confirming that data acquired from the ULIP platform was repeatable, reproducible, and accurate. As reflected in the representative photo below, staff determined that the geospatial data for change in level locations was accurate and that individual heaves could be readily identified on the field.





ADA Self-Evaluation Report

The map below shows heaving in an area in downtown Bellevue. The data collected for this project allows detailed maps such as this to be created for any neighborhood in Bellevue.

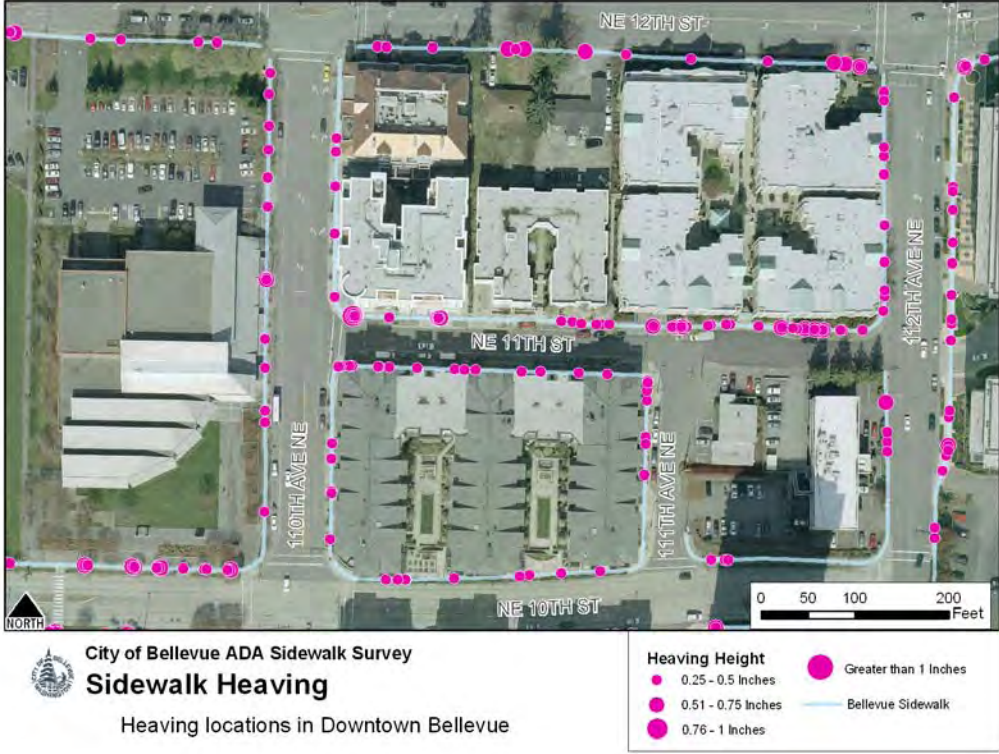

Heave Category	Heave Height	Weighing factor	Total number
C1	0.25" - 0.5"	1	20,002
C2	0.51" - 0.75"	2	7,014
C3	0.76" - 1"	3	274
C4	> 1"	4	268

Bellevue’s sidewalk inventory project identified a total of 27,558 sidewalk locations with a change in level (heave). On average, this is about one heave per 61 feet of sidewalk, though in reality heaves often occur in clusters. A majority—73% of the heaves fall in the 0.25 to 0.5 inch category. Only 542 (2%) heaves have a vertical displacement of 0.76 inch or greater. The data show that although minor sidewalk surface irregularities are common, only a small number of heaves have the potential to severely affect accessibility.

Given the number of heaves in Bellevue, mapping was based on the number of heaves per mile of sidewalk in a grid overlay made up of cells measuring approximately 3,000 feet to a side. The use of a grid provides a clear way to visualize the density of heaves per unit of sidewalk on a map. The heaves were divided into four categories as seen in the map on page 45.

Sidewalk Inventory



The heaving index below aggregates the four heaving categories, giving a higher weight to the larger heaves. It is clear from the map that Downtown Bellevue, the Richards Road and Bel-Red corridors, the Newport Hills neighborhood, and the northeast corner of Bellevue have high heaving index scores.

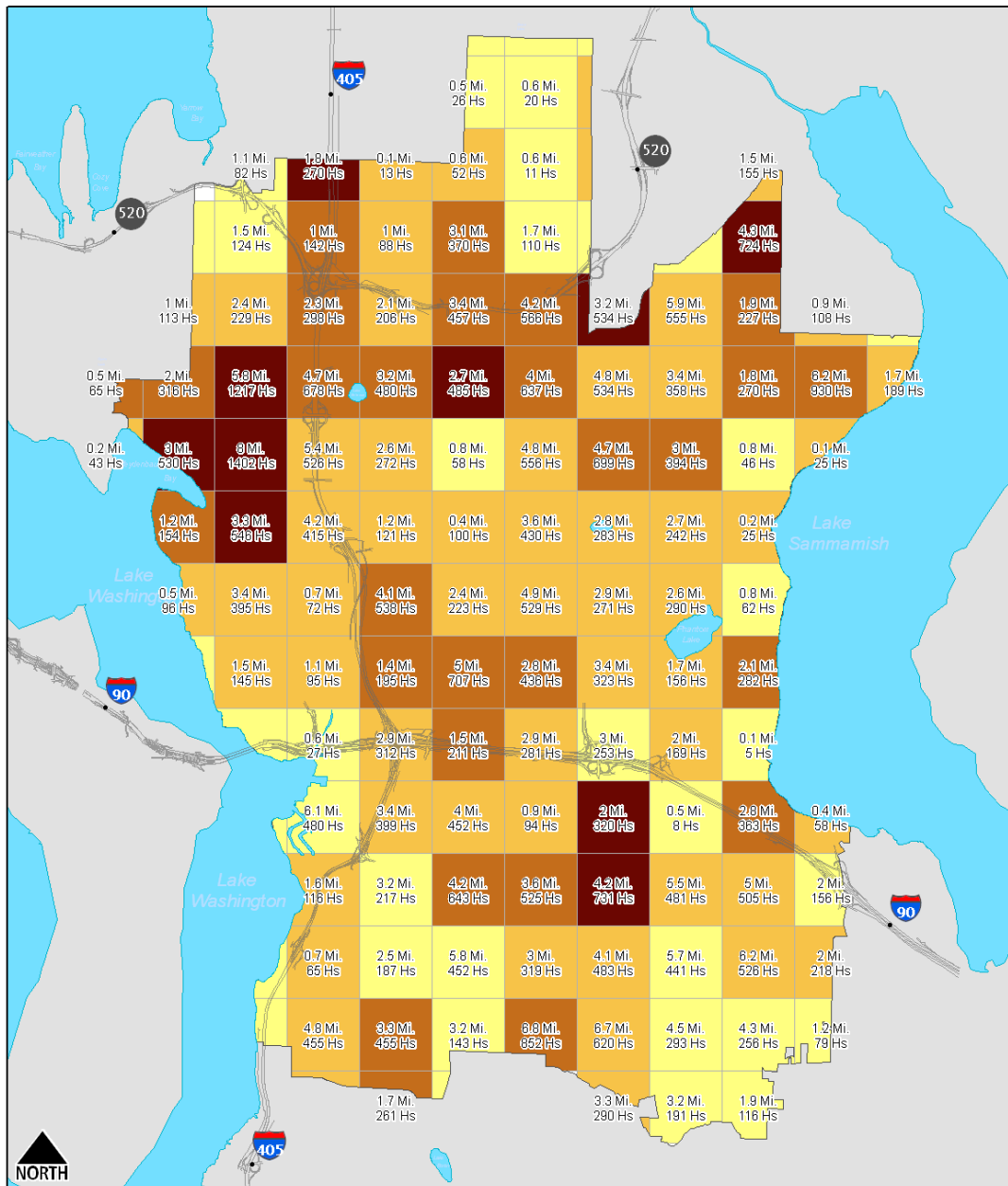

City of Bellevue ADA Sidewalk Survey Sidewalk Heaving

Heaving Index

$$= [(C1 * 1) + (C2 * 2) + (C3 * 3) + (C4 * 4)] / \text{Sidewalk Miles}$$

Labels indicate miles of sidewalk and total number of heaves per tile.

Heaving Index

- 0 - 100
- 101 - 150
- 151 - 201
- 202 - 266
- Highways



ADA Self-Evaluation Report

Grade (Running Slope)



Sidewalk grade of 22% on 166th Avenue SE between Phillips Road and SE 39th Place.

Steep sidewalk grades are a barrier for many pedestrians. Powered and manual wheelchairs can become unstable and/or difficult to control on sloped surfaces. These areas are even more difficult for sidewalk users who are disabled to access when wet.

Grade (running slope) is defined as the slope parallel to the direction of travel and is calculated by dividing the vertical change in elevation by the horizontal distance covered. Although some guidelines use the term “running slope” instead of “grade,” the term “grade” is used in this report to avoid confusion with cross-slope.

Running grade is defined as the average grade along a contiguous sidewalk segment. Measuring running grade only does not give an accurate understanding of the sidewalk environment because small steep sections may not be detected.

Maximum grade is defined as a limited section of path that exceeds the typical running grade. The image below provides an example of a typical grade that is fairly negotiable, with a maximum grade that could be very difficult for some users to traverse. In the illustration, the running grade between Points A and D is 5 percent, but the grade between Points B and C is 14 percent. A person who could negotiate a 5 percent grade might not be able to negotiate a 14 percent grade, even for short distances.

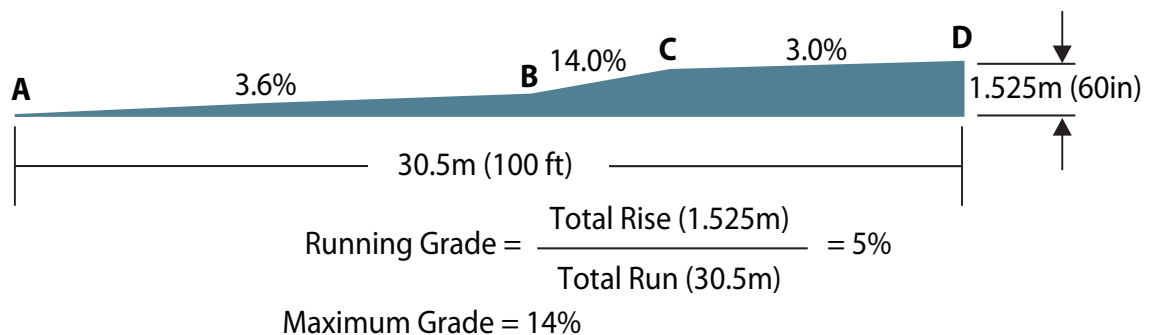

In *Designing Sidewalks and Trails for Access*, the Federal Highway Administration suggests measuring maximum grade over two foot intervals (the approximate length of a wheelchair wheelbase, or a single walking pace). For the purposes of this report, grade is measured over two foot intervals.

The ULIP captures fine-grained data values in the pedestrian environment that, when post-processed, provide the City with maximum sidewalk grade values. During data collection, the ULIP measured grade using the gyroscope pitch angle, the mechanical

Sidewalk Inventory



layout of the ULIP and the sensor box, the position and calibration of the laser, and the measured distance from the laser to the pavement. During post-processing, rider specific adjustments are made based on the rider's weight as this determines the level of compression on the tires and the wheel radius. A DMI (distance measurement instrument) calibration is also used to determine the wheel circumference for the given tire pressure and rider. This calibrated distance measurement and rider specific calibration for the radius are key parameters in the processing of ULIP grade data.

Maximum grade values are then derived from smoothing ULIP raw sensor data using a two foot moving average window (incremented every 0.1 foot data interval). If the grade window was any larger much of the extreme data collected would be lost because of the averaging factor. With the grade window size of two feet, Bellevue can detect small step sections including the maximum grades.

Once the two foot moving window is used to smooth the raw data, sidewalk segments are then categorized by different ramp types according to American with Disabilities Act Accessibility Guidelines (ADAAG) standards. According to ADAAG 4.3.7 any sidewalk with a grade greater than 1:20 (5%) is considered a ramp. ADAAG 4.8.2 sets the maximum grade of a new curb ramp at 1:12 (8.33%) to provide maximum usability for the widest range of people who have mobility impairments. The maximum rise for any run is 30 inches. In existing, developed rights-of-way, it may be necessary to install a steeper ramp to provide access to street crossings ADAAG 4.1.6 (3)(a). In an alteration, grades as steep as 1:10 (10%) are permitted for the distance of a 6 inch rise if it not technically feasible to provide a ramp at 1:12 (8.33%). For a 3 inch rise, the maximum grade may be as steep as 1:8 (12.5%) where necessary.

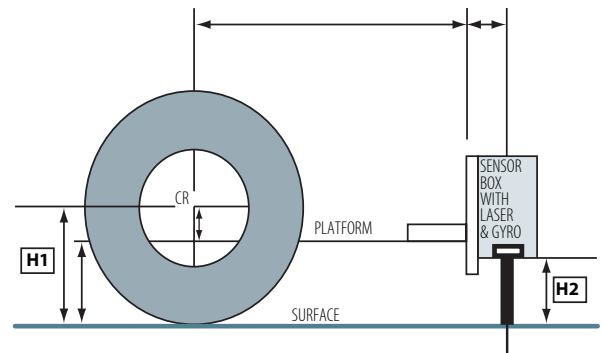

Data processing is based on a geometric calculation of the laser's height on the ULIP relative to the pavement surface.

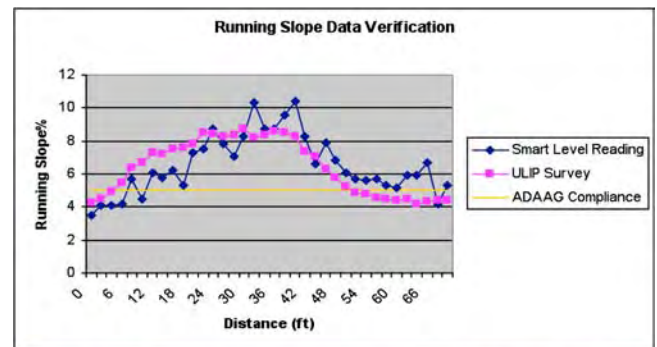

During the sidewalk inventory effort, the City employed a rigorous QA/QC protocol for validation testing of the data results. Field verification of ULIP results involved taking smart level measurements of sidewalk grade every 2 feet over a 70 foot span. Numerous assessments of ULIP data, evaluated at the same interval as the smart level (2 feet), confirmed that the ULIP grade data provides an accurate interpretation of the geometry of the sidewalk profile. The images above reflect the results of a field test of ULIP sidewalk grade at 174th Avenue NE and NE 11th Street.



ADA Self-Evaluation Report

Sidewalk Grade (Ramp Type) Classification

	Slope	Max Rise (inch)	Max Run (feet)		Ramp Type
≥	5.0%	0	0		1
≥	5.0%	30	50	1:20	30
	5.5%	30	45.5		
	6.0%	30	41.7		
	6.5%	30	38.5		
	7.0%	30	35.7		
	7.5%	30	33.3		
	8.0%	30	31.3		
<	8.33%	30	30.0	1:12	
	8.33%	6	6.0	1:12	6
	8.5%	6	5.9		
	9.0%	6	5.6		
	9.5%	6	5.3		
<	10.0%	6	5.0	1:10	
>	10.0%	3	2.5	1:10	3
	10.5%	3	2.4		
	11.0%	3	2.3		
	11.5%	3	2.2		
	12.0%	3	2.1		
≤	12.5%	3	2.0	1:8	
>	12.5%	>1.5	1.0		99

The ADAAG sidewalk criteria are applied in succession to ULIP’s vertical profile data where sidewalk “rise” versus “run length” is compared to the criteria in the table at right. In this framework, ramp type 1 meets the definition of a ramp (≥ 5%) but is not regarded as having a non-standard grade. Ramp type 30 has a rise of 30” and run between 30’ and 50’ (5% ≥ x ≤ 8.33%). Ramp type 6 has a rise of 6” and run between 6’ and 5’ (8.33% ≥ x ≤ 10%). Ramp type 3 has a rise of 3” and run between 2’ and 2.5’ (10% ≥ x ≤ 12.5%). Ramp type 99 has a rise greater than 1.5” over 1’ (>12.5%).

Reflected in the table below are the results of the sidewalk grade analysis, which shows approximately 39 miles of sidewalk in the city that do not meet grade standards. To accurately detail the rate of change for grade over small distances, Bellevue’s self-evaluation inventory classifies non-standard sidewalk segments into four grade designations.

Sidewalk Grade Assessment

Grade Category	Length (Miles)	%
5-8.33%	32	82%
8.34-10%	4	10%
10.01-12.5%	2	5%
12.5%	1	3%
Total	39	100%

The table above does not reflect the 95 miles of non-standard grade features deemed “technically infeasible.” Under some conditions, the City is limited in its ability, or completely unable, to provide sidewalks and curb ramps that meet ADAAG grade requirements because of existing site constraints. According to ADAAG standards, sidewalk grade should not exceed 5 percent. However, grades are often too difficult to control in the sidewalk environment because sidewalks follow the path of the street and the natural topography of the area.

Sidewalk Inventory



Bellevue's GIS database played a pivotal role in determining which of the non-standard sidewalk grade profiles were deemed technically infeasible due to roadway topographic factors. Bellevue staff developed a GIS script that enabled a comparison of every non-standard sidewalk segment to the grade of the adjacent roadway. Adjacent roadway grade profiles were derived from a digital elevation model, a representation of ground surface topography. Criteria were then used to filter out 95 miles of non-standard sidewalk grade locations deemed technically infeasible.

Bellevue's decision to screen profile data is consistent with currently recommended best practices from the U.S. Access Board and FHWA to make allowances for the sidewalk grade to follow the grade of the associated roadway, instead of the 5% maximum grade for walkways or an 8.3% maximum grade for ramps. In situations like these, the Department of Justice notes that "occasionally the nature of a facility makes it impossible to comply with all of the alteration standards. In such a case, features must only be made accessible to the extent that it is technically feasible to do so."

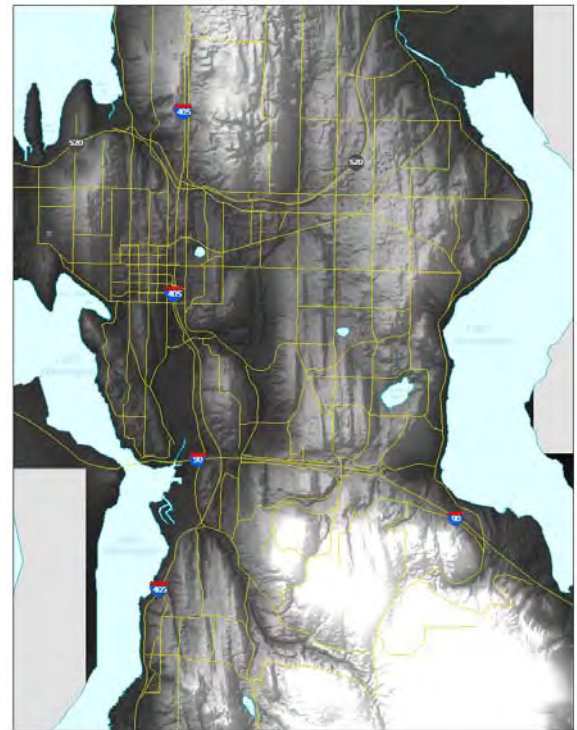

Bellevue's digital elevation model provides the elevation of any point within the city. The lighter areas indicate higher elevations whereas the darker indicate lower.



The sidewalk segments (depicted in both red and green) along NE 8th Street and 148th Avenue NE were initially classified as having non-standard ADAAG grade values. After running its GIS script, Bellevue reclassified those sidewalk segments where the adjacent road grade is greater than 5% (red) as technically infeasible. Sidewalk segments with non-standard grades and adjacent to road grades that are less than 5% (green) are identified as a barrier in the ADA Self-Evaluation Report.



The sidewalk segment with a yellow circle around it in the ortho-image at left is again reflected in the photo above. As indicated in the image above, the sidewalk is steeper than the terrain of the streets which at this location has a grade of 5%. Given these conditions, the sidewalk is classified as a ramp type 30 in the ADA Self-Evaluation Report.



ADA Self-Evaluation Report

Cross Slope



*"In Washington State, because we have slopes, sometimes even if the pathway looks smooth, when I walk on it, then I can feel an incline, then I have to worry about my balance. I have to adjust my balance really quickly and sometimes I can't do it quickly enough and I fall down."
~ Bellevue resident 4 years*

Cross slope is defined as the slope measured perpendicular to the direction of travel. Most sidewalks are built with some degree of cross slope to allow water to drain into the street and to prevent water from collecting on the path.

Excessive cross slope on sidewalks is a major issue for pedestrians who use wheelchairs, scooters, walkers, and crutches. In severe cross slopes, sidewalk users must maintain their lateral balance because they must work against the force of gravity. People using canes or crutches may be forced to turn sideways in order to keep their base support at a manageable angle. Because the cross slope of a sidewalk is typically toward the roadway, the pedestrian who loses traction or balance will be directed toward the street.

ADAAG 4.3.7 does not permit cross slopes to exceed 2 percent. The 2% sidewalk cross slope requirement is intended to be an in-place, finished-product construction standard. Current and proposed accessibility guidelines offer no specific guidance on acceptable maximum cross slopes where constraints of reconstruction prohibit meeting the 2% maximum cross slope requirement for new construction.

In the City of Bellevue's sidewalk inventory, cross slope was measured with the ULIP. Consistent with FHWA guidance, a two foot moving window is used in processing the data because it best represents the approximate length of a single walking pace or a wheelchair base. According to FHWA "a cross-slope that changes so rapidly that there is no planar surface within 2 ft could create a safety hazard. As the wheelchair moves over a surface that is severely warped, it will first balance on the two rear wheels and one front caster. As the wheelchair moves forward, it then tips onto both front casters and one rear wheel. This transition could cause the wheelchair user to lose control and tip over."

Reflected in the table on page 51 are the results of the sidewalk cross slope analysis, which shows that there are approximately 212 miles of non-standard (greater than 2 percent cross slope) sidewalk in the city. To accurately detail the rate of change for cross slope over small distances, Bellevue's self-evaluation inventory classifies non-standard sidewalk segments into five cross slope designations. As reflected in the table, the majority (134 miles or 63%) of non-standard cross slope measurements

Sidewalk Inventory



are found to have profiles of 2-4 percent. Sidewalks with profiles of 10+ percent account for 7 miles or 3% of all non-standard cross slope measurements. The table also reflects how many of these non-standard cross slope features are attributable to driveways in Bellevue.

Sidewalk Cross Slope and Driveway Design Practices Assessment

Cross Slope Category	Total Length (Miles)	Cross Slope within Driveway Buffer (Miles)	Cross Slope without Driveways (Difference)	% Attributable to Driveways
2-4%	134	18	116	13%
4-6%	49	9	41	17%
6-8%	15	5	10	31%
8-10%	7	4	3	54%
10%+	7	5	2	70%
Total	212	40	172	19%

Driveway crossings are often built with grade changes in the sidewalk corridor that have cross slopes greater than 2 percent. As reflected in the table above, driveway aprons are the most frequently encountered example of excessive cross slope along a pedestrian route. More than 50% of Bellevue's 8+ percent cross slope measurements are attributable to driveway aprons. This number increases as the cross slope values increase, with 70% of Bellevue's 10+ percent cross slope measurements attributable to driveway aprons. Overall, 19% of all non-standard cross slope measurements in Bellevue are attributable to driveway aprons constructed like ramps, with steep, short side flares.

The following are representative concerns expressed about driveways from the focus groups held in support of the ADA Self-Evaluation Report.

- “I don't like going up or down driveways. No matter what kind. I find that driveways that have a slope and an incline at the same time are a real obstacle course for me. It's a little easier with the wheelchair because its electrical ability allows me to take slopes for granted, but for walkers or if I'm with someone, it's like holding two people's hands to get me up, and it's something I don't want to do.”



The driveway analysis is based on ULIP recordings taken by field staff at the center points of driveways along a given sidewalk. Using GIS, a 26 foot buffer (standard driveway width) was then applied to these points. All non-standard cross slope values within the buffer were attributed to the driveway aprons.



ADA Self-Evaluation Report



A series of driveway apron flares with 11% cross slope measurements at 130th Avenue SE & SE 26th Street.

- “With the level ones, even if I do need someone’s hand or someone needs to be there to watch me, are a lot smoother to go down. But the driveways, like the houses that are on a steep hill or on some kind of incline, those are really hard to gauge because even if I’m on the slope, all of a sudden I might step somewhere and there might be an incline and trying to accommodate my balance fast enough before I fall down is hard.”
- “One of the things I think would be really beneficial is if the driveway was flat, unlike the driveway of the house I live in. It’s actually fairly steep, and if you’re not being careful, you’re going to be rolling down it into the middle of the street.”

To maintain an acceptable cross slope and facilitate wheelchair movement at driveways, the City of Bellevue employs a number of accessible driveway design templates in its Design Manual. As reflected in DEV-7D below, securing additional right-of-way from the adjacent property is a good strategy for improving pedestrian access on narrow sidewalks. This design allows pedestrians to maintain a level path as they cross the driveway.

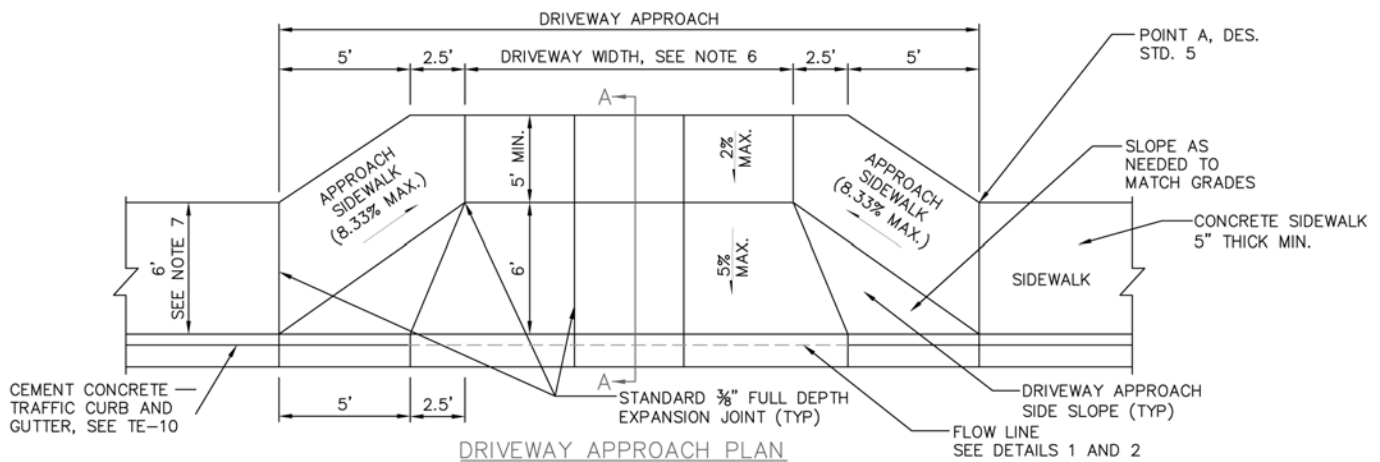

Sidewalk Inventory



Sidewalk Barrier Ranking Analysis

The following comment, offered by a Bellevue resident who has multiple sclerosis, conveys the importance of ensuring that sidewalks are designed to ADA standards.

“Sometimes I’ve found that it was very difficult for me to go anywhere just because it wasn’t accessible. Now, with these changes that are being made, it makes things much easier, much more beneficial for me to get to where I need to go without having to force my way to do anything.”

Although ADA tells us which sidewalk features are non-standard it does not offer guidance on which non-standard sidewalk location should be repaired or replaced first. The final stage of the ADA Self-Evaluation Report process was to screen the 3,504 sidewalk block faces in Bellevue (321 miles) to determine which of these sites required more immediate attention.

Sidewalk activity and impedance scores – found in the technical appendix report – were sorted according to their magnitude and divided into three categories (high/medium/low) using natural breaks. The sidewalk block face natural break categories are as follows: (i) activity score (low = 0-40; medium = 41-56; high = 57-100); and, (ii) impedance score (low = 0-24; medium = 25-56; high = 57-100).

As indicated in the table below, of the 3,504 sidewalk block faces in Bellevue: (i) 1 percent (the smallest share) had a combined high impedance and high activity score (together, these 45 block faces represent 4.37 miles of sidewalk in Bellevue; and, (ii) 32 percent (the largest share) had a combined low impedance and medium activity score (together, these 1,113 sidewalk block faces represent 102 miles of sidewalk in Bellevue).

Data for sidewalk activity and impedance was layered to derive a composite barrier ranking score for a particular



Rubber sidewalk panels at NE 10th Street west of 102nd Avenue NE allow tree roots to grow under the sidewalk without creating a change in level barrier for people with disabilities.

Sidewalk Block Face Activity and Impedance Ranking

Activity	Impedance	Blocks	Mileage	Percent
High	High	45	4	1%
High	Medium	157	17	4%
High	Low	429	39	12%
Medium	High	125	10	4%
Medium	Medium	435	37	12%
Medium	Low	1,113	102	32%
Low	High	98	7	3%
Low	Medium	802	27	23%
Low	Low	300	76	9%
Total		3,504	321	100%



ADA Self-Evaluation Report

block face. Reflected in the table below are the final results of the barrier ranking analysis; categorized using natural breaks as follows: low = 0-64; medium = 65-97; high = 98-200. As indicated, 11 percent (the smallest share) had a high barrier ranking. Together, these 399 block faces represent 35 miles of sidewalk in Bellevue.

Sidewalk Block Face Barrier Ranking Score

Barrier Ranking	Block Face	Miles	Percent
High	399	35	11%
Medium	1,358	124	39%
Low	1,747	161	50%
Total	3,504	321	100%

The following is an example of how the barrier scoring process makes use of activity and impedance score categories. Block ID: 1035 (NE 8th Street between 106th and 108th Ave NE) received a high impedance score (100 points) and a high activity score (70 points). With a combined barrier ranking score of 170, this block face is among the top 10 highest ranked sidewalk segments in the ADA Self-Evaluation Report.

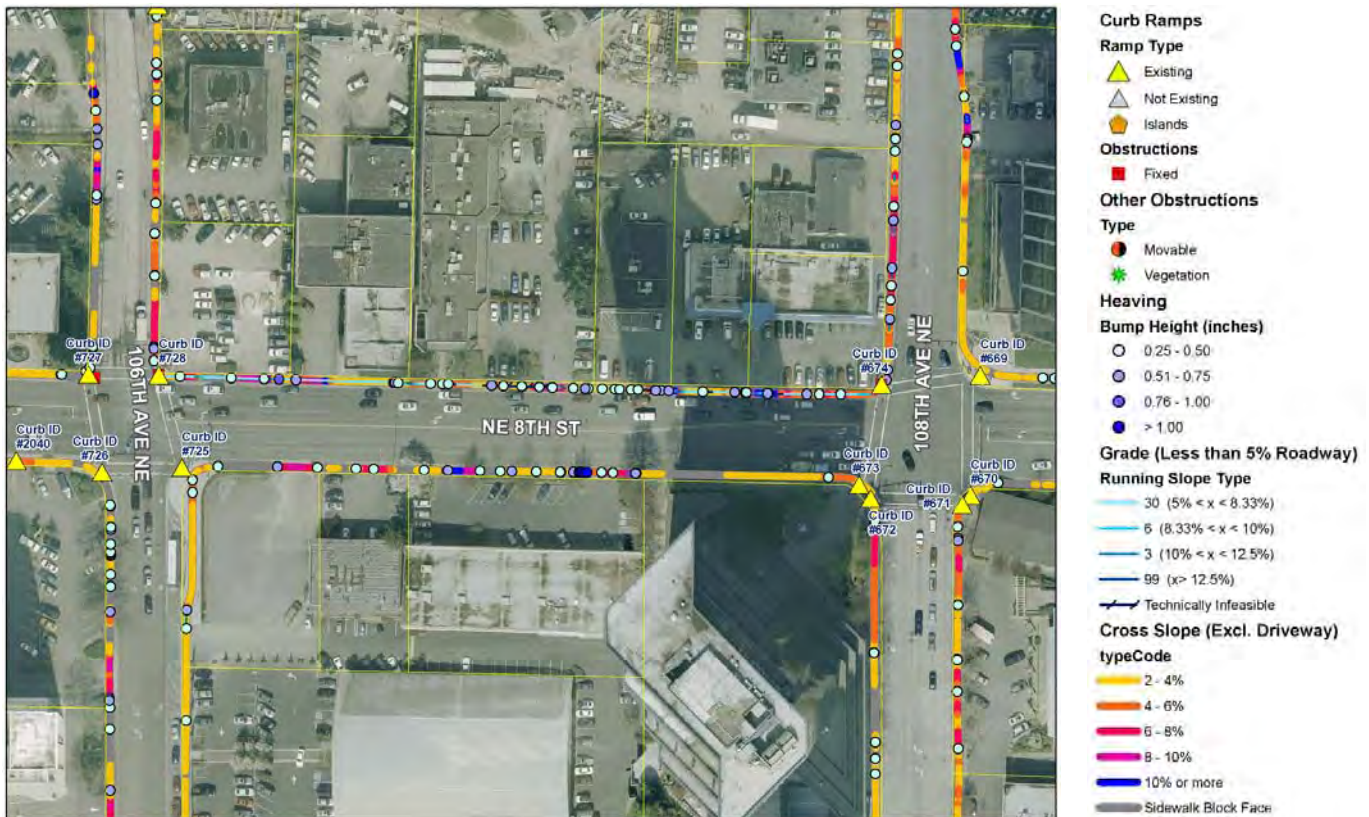

Sidewalk Inventory



Inventoried during the 2008 ADA field inventory effort, Block ID: 1035, was subsequently improved as part of the NE 8th Street widening project (Winter-Summer 2009). A new sidewalk and curb ramps were built next to the new westbound lane. As indicated in the before and after images below, the project enhanced pedestrian facilities by removing fixed obstructions and improving sidewalk surface conditions (both changes in level and slope variations). This was an important project because it addressed barriers to accessibility in a downtown Bellevue location known to have high volumes of pedestrians.



In the technical appendix report are maps that help the reader to visualize and analyze the sidewalk activity and impedance data. In these maps, we see the spatial relationships between activity and impedance scores and are able to prioritize improvements where they are most needed. Reflected in the image below is a snapshot of this merger of data-sets for Block ID: 1035.





ADA Self-Evaluation Report



"I think if the ramps are more aligned to the ADA standards, then I can take out my walker more, and not have to worry about having somebody else with me."

~ Bellevue resident for 3 years

This section of the ADA Self-Evaluation Report assesses the status of Bellevue's ramp locations. Curb ramps are structural features that ease access to and from sidewalks, and are a critical part of the City of Bellevue's pedestrian network. Well-built and strategically located curb ramps greatly improve connectivity and safety on the sidewalk network. Without curb ramps, people who use wheelchairs would not be able to independently access the sidewalk and street.

Title II of the ADA requires state and local governments to make pedestrian crossings accessible to people with disabilities by providing curb ramps. To comply with ADA requirements, the curb ramps provided must meet specific standards for width, running slope, cross slope, placement, and other features. These guidelines are summarized below.

Methodology

The City of Bellevue's ADA field technicians recorded 4,586 ramp locations using a Topcon GMS-2 handheld Global Positioning System (GPS) device. Because GPS was deemed inaccurate in establishing the position of the ramp location, the City's field technicians relied on ortho-photography and an ArcPad interface on the GMS-2 to correctly identify



the precise point at the site of a curb ramp. After recording the location of each ramp, field technicians used a SmartLevel and tape measure to determine slopes and widths, entered these values in the appropriate data fields, and captured a digital image of the site.

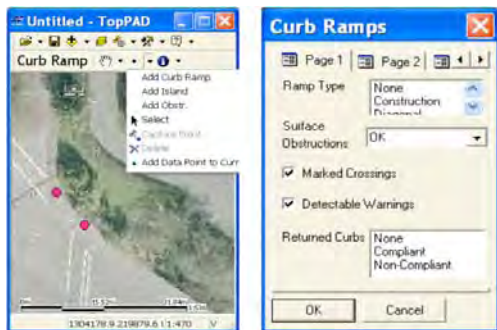

To collect data accurately and efficiently, Bellevue's field technicians needed a comprehensive set of definitions for curb ramp attributes. The data dictionary employed for the inventory was:

Field technicians documented each curb ramp barrier including geospatial coordinates, type of barrier, notes, and a digital image.

Curb Ramp Inventory



- *Obstruction*: Free of objects that limit the vertical passage space, protrude into the circulation route, or reduce the clearance width of the curb ramp (yes, no)
- *Ramp type*: Directional; Perpendicular; Diagonal; Construction; None (indicates no ramp where ramp is needed)
- *Gutter running slope*: Standard ($\leq 5\%$); Non-standard ($> 5\%$)
- *Gutter cross-slope*: Standard ($\leq 5\%$); Non-standard ($> 5\%$)
- *Transition*: Free of heaves, gaps, and obstructions (yes/no)
- *Clear space at bottom*: 48" of clear space at the bottom of a diagonal ramp, within marked crosswalk (yes/no)
- *Detectable warnings*: 2' x 4' yellow panel of truncated domes adjacent to gutter transition (yes/no)
- *Marked crossings*: Curb ramp wholly contained within crosswalk markings (yes/no)
- *Landing slope*: Landing slope does not exceed 2% in any direction (yes/no)
- *Landing panel*: None (non-standard); ≥ 48 in. (standard); 36-47 in. (non-standard); < 36 in. (non-standard)
- *Ramp width*: ≥ 48 in. (best practice); 36-47 in. (standard); < 36 in. (non-standard)
- *Ramp slope*: $< 8.3\%$ (standard); 8.3% - 10% (non-standard); $> 10\%$ (non-standard)
- *Ramp cross-slope*: $\leq 2\%$ (standard); 2% - 4% (non-standard); $> 4\%$ (non-standard)
- *Ramp flares*: None; $\leq 10\%$ (standard); 10.1% - 12% (non-standard); $> 12\%$ (non-standard)
- *Returned curbs*: None (if no ramp flares); Standard (ramp is situated such that pedestrians will not walk across returned curbs); Non-standard (returned curbs may present tripping hazard)

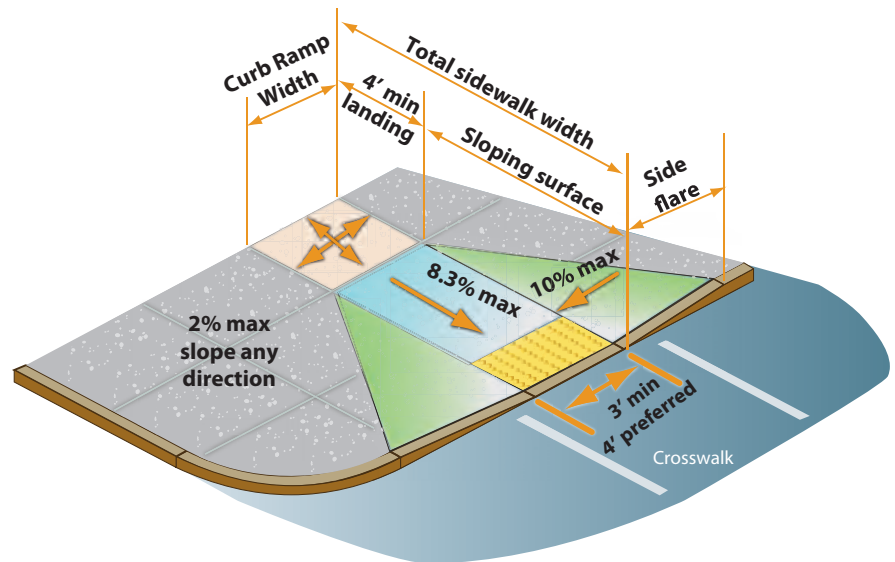

Dimensional and slope features documented in the ramp inventory.

Curb Ramp Categories

Over the course of the curb ramp inventory, Bellevue staff assessed 4,586 ramp locations. At each of these locations the field technicians noted the absence or presence of a ramp, and in the case of an existing ramp, measured its features



ADA Self-Evaluation Report

based on ADAAG standards. Field staff began by classifying the ramp as one of the following: “none” (meaning there was sidewalk but no ramp access); “construction” (meaning an existing ramp was inaccessible due to construction); or one of five existing ramp types (perpendicular, parallel, island/median, directional, or diagonal).

Bellevue’s field technicians identified 1,041 “none” locations (representing 23% of all ramp locations) and 34 “construction” locations. As reflected in the figure below, an interruption to sidewalk connectivity is caused by the intersecting street network. Curb ramps located on the corners can preserve continuity of the sidewalk network.

Street Crossing Illustration without Curb Ramps



The figure below shows the categories of the 3,511 existing curb ramps in Bellevue differentiated by category.

Existing Curb Ramps by Category

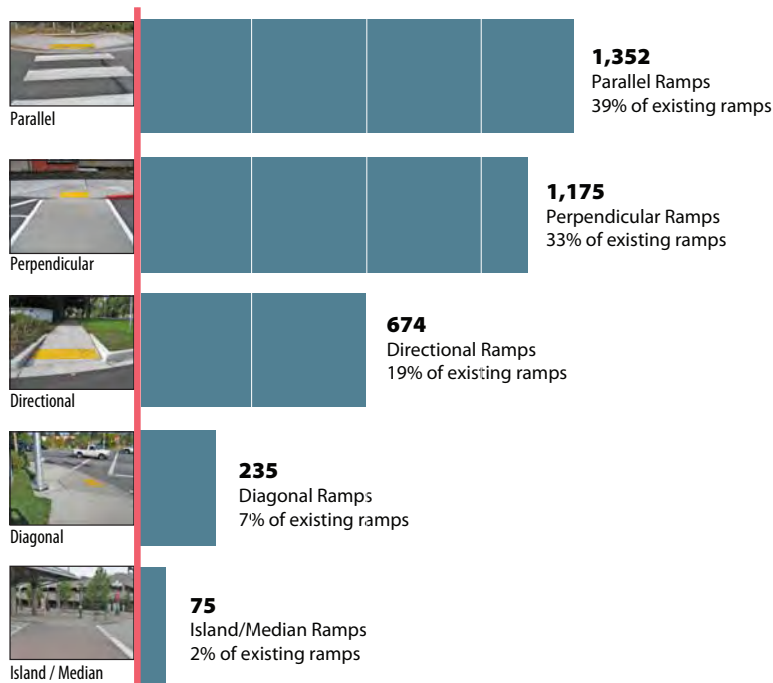

Locations: perpendicular, parallel and island/median ramps at NE 24th Street and 164th Avenue NE; directional ramp at NE 24th Street and 167th Avenue NE; diagonal ramp at Northup Way and 130th Avenue NE.

Curb Ramp Inventory



Curb Ramps and Islands

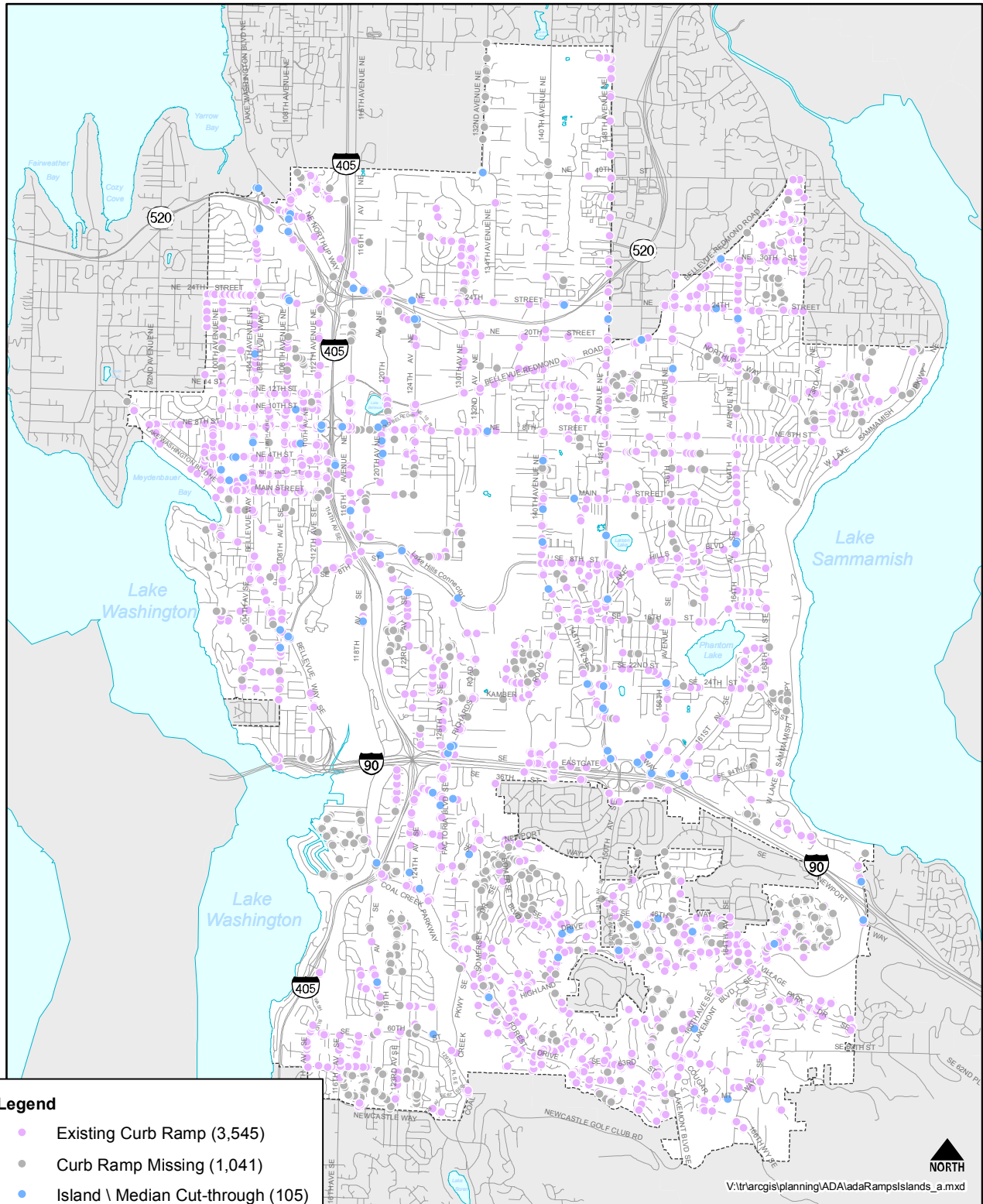



ADA Self-Evaluation Report

Perpendicular ramps are situated perpendicular to the sidewalk path of travel and users will generally be traveling perpendicular to vehicular traffic when they enter the street at the bottom of the ramp. They often include flares to mediate the transition between the sidewalk level and the downward sloping ramp panel. In Bellevue, there are 1,175 perpendicular ramps (33% of all ramp locations).

Perpendicular Ramps



-  Ramp
-  Landing Panel
-  Flare
-  Curb
-  Gutter
-  Crosswalk
-  Detectable Warning
-  Path of Travel

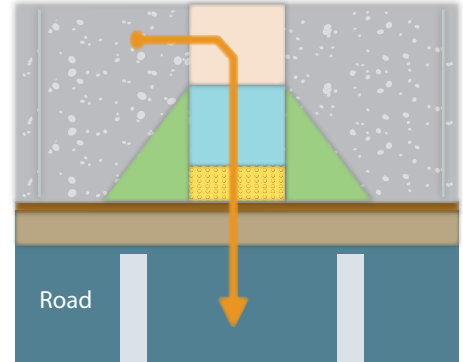

A parallel curb ramp has two ramps leading down toward a center level landing at the bottom between both ramps with a level landing at the top of each ramp. A parallel curb ramp is one that is oriented so that the path of travel on the ramp is parallel to the vehicular path of travel on the adjacent street and user's path of travel on the sidewalk. In Bellevue, there are 1,352 parallel ramps (39% of all ramp locations).

Parallel Ramps



-  Ramp
-  Landing Panel
-  Returned Curbs
-  Curb
-  Gutter
-  Crosswalk
-  Detectable Warning
-  Path of Travel

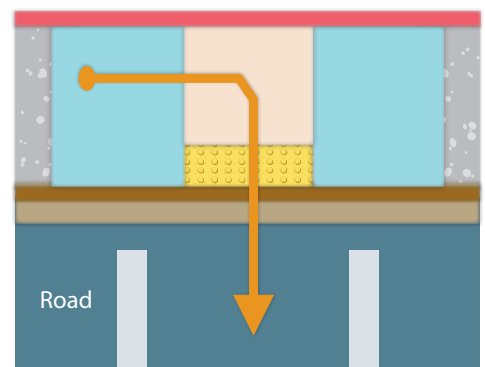

Curb Ramp Inventory



Directional ramps run parallel to the pedestrian path of travel and lead sidewalk users into the crosswalk. They consist of a landing and ramp panel and optional returned curbs to separate adjacent landscaping from the sidewalk area and to guide pedestrians toward the ramp descent. In Bellevue, there are 674 directional ramps (19% of all ramp locations).

Directional Ramps



- Ramp
- Landing Panel
- Returned Curbs
- Curb
- Gutter
- Crosswalk
- Detectable Warning
- Path of Travel

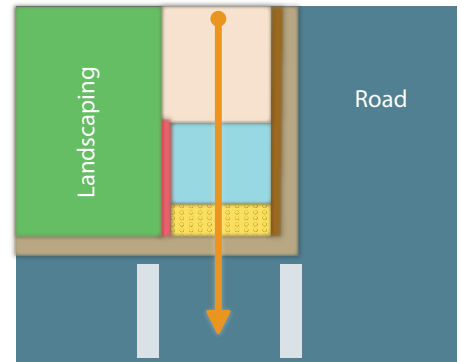

A diagonal ramp is located at the apex of a corner. It is aligned so that: (i) a straight path of travel down the ramp will lead diagonally into the center of the intersection; (ii) the ramp is diagonal to the user's path of travel; and, (iii) users will be traveling diagonal to the vehicular traffic when they enter the street. In Bellevue, there are 235 diagonal ramps (7% of all ramp locations).

Diagonal Ramps



- Ramp
- Landing Panel
- Flare
- Curb
- Gutter
- Crosswalk
- Detectable Warning
- Path of Travel

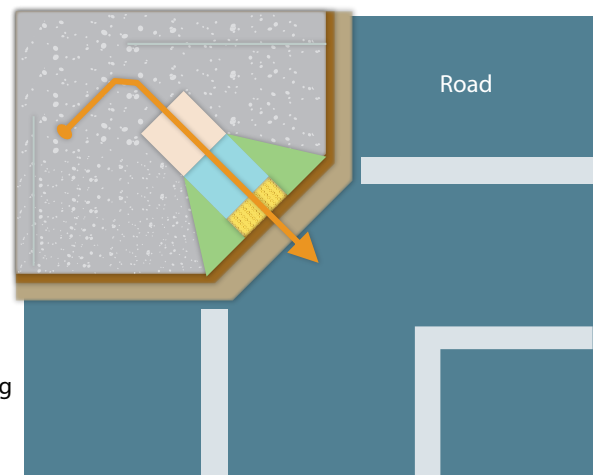



ADA Self-Evaluation Report

Island/median ramps are not defined by their structural form, but by their location on an island or median. Like diagonal ramps, island/median ramps can be configured as perpendicular, parallel, or directional ramps. They often share a large landing panel which directs pedestrians from the ramp on one side of an island to the ramp on the other side. They sometimes have returned curbs (raised curb segments that separate the pedestrian path of travel from potential hazards) as a way to direct pedestrians through the cut through. In Bellevue, there are 75 island/median ramps (2% of all ramp locations).

Island / Median Ramps



-  Ramp
-  Landing Panel
-  Returned Curbs
-  Curb
-  Gutter
-  Crosswalk
-  Detectable Warning
-  Path of Travel

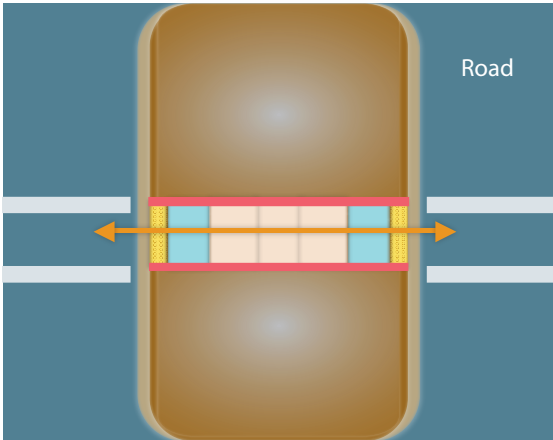

The majority of pedestrian islands/medians in Bellevue are designed with a cut-through design (105 locations). Although not required by ADAAG, cut-throughs are preferred over ramps, as most islands are not large enough to comfortably fit two ramps and a 4-foot level landing between the ramps as required by ADA.



Pedestrian median with a cut-through design provides people with disabilities a point of refuge when crossing at 164th Avenue NE south of NE 24th Street.

Guidance on cut-through design is that they should be at least 3' wide, 6' length in the direction of pedestrian travel, wholly contained within crosswalk markings, and have detectable warning surfaces spanning the full width of the cut-through. Of the 105 cut-through islands/medians in Bellevue: 2 had a non-standard width; 37 had a non-standard length; 20 had a non-standard containment within crosswalk markings; and, 82 had a non-standard warning surface.

Curb Ramp Assessment

ADAAG sets standards for each ramp feature. The federal standards outlined below correspond to the following features: (i) returned curbs; (ii) flares; (iii) ramp panels;

Curb Ramp Inventory



(iv) transitions; (v) gutters; (vi) landing panels; (vii) detectable warnings; (viii) marked crossings; and, (ix) a clear space at bottom. For each feature there is also a discussion of Bellevue's curb ramp inventory findings.



 Returned curb

Location: NE 24 Street & 167 Ave NE

- i. *Returned curbs* are raised curb segments that separate the pedestrian path of travel from potential hazards. In the examples above, returned curbs separate pedestrians from adjacent landscaping or private property. Not all ramps need to have returned curbs to comply with ADAAG, but if they are present, returned curbs must be located so that pedestrians will not traverse them or trip over them. The GMS-2 input options for measuring returned curbs were: (i) none; (ii) standard (ramp is situated such that pedestrians will not traverse returned curbs); and, (iii) non-standard (returned curbs may present tripping hazard). Field staff found that 306 (9%) of the 3,511 existing ramps had returned curbs. Of the 306 returned curbs, only 11 (4%) are non-standard.



ADA Self-Evaluation Report

- ii. *Ramp flares* are panels on either side of a ramp to mediate the difference between the sidewalk level and the descending ramp panel. Because they are usually accessible from the sidewalk and function as an entry point from the sidewalk to the ramp when the ramp landing is blocked or missing, they should not be excessively steep. Ramps do not need to have flares to align with ADAAG standards, but if they do have them, the flare slopes must not exceed 10% in any direction. The field team found that 1,477 (41%) of the 3,511 existing ramps had flares. Of the 1,477 ramps with flares: 457 (32%) were standard (flare is $\leq 10\%$); 225 (16%) were non-standard (flare is 10.1% – 12%); and, 765 (53%) were highly non-standard (flare is $> 12\%$).

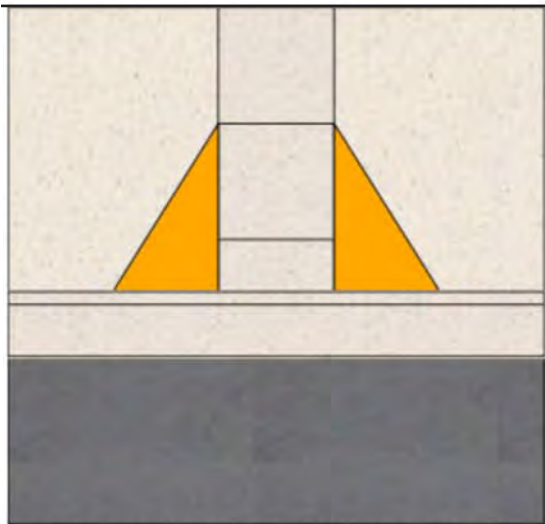

 Flare

Location: NE 24 Street & 164 Ave NE

- iii. *Ramp landings* are the level panel at the top of a perpendicular or directional ramp and at the bottom of a parallel ramp. Landing panel accessibility is based on slope and size.

ADAAG 4.8.4 specifies that landings with a minimum length of 48 inches, the length of an occupied wheelchair, will provide sufficient turning space. Landing length is measured in the direction of travel to and from the ramp. The field team found that of the 3,511 existing ramps: (i) 2,276 (65%) were standard with landing panels ≥ 48 "; 283 (8%) were with landing panels between 36"-48"; (iii) 161 (5%) were with landing panels smaller than 36"; and, 791 (23%) were highly non-standard with no landing panel.

Slope is an important accessibility measure for landing panels. ADAAG specifies that landing panel slopes should not exceed 2% in any direction. Since landing

Curb Ramp Inventory



panels are a place where pedestrians will pause and reorient themselves either toward the sidewalk (in the case of a perpendicular ramp) or toward the street, these spaces should be flat. The field team found that 2,791 (79%) of the 3,511 existing ramps had non-standard ramp panel slopes of greater than 2%.



 Landing Panel

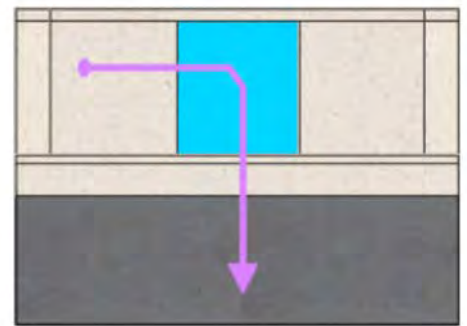
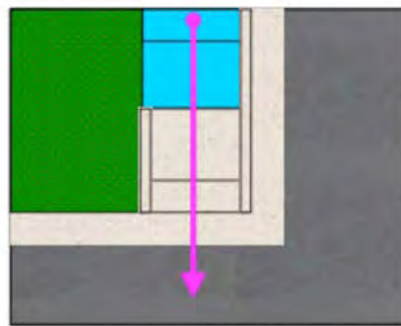
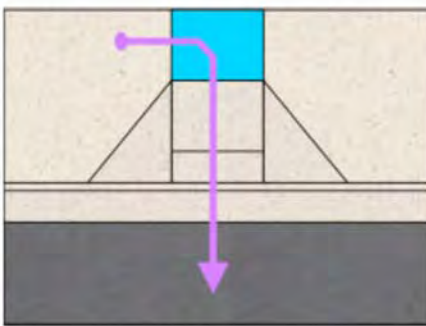

Locations: NE 24th and NE 167th

- iv. *Ramp panels* bring a pedestrian from the level of the sidewalk down to the level of the street. They are components of all ramps. Ramp panel standards are based on ramp width, ramp running slope, and ramp cross slope.

Most wheelchairs have a minimum width of 28"; 36" of width is necessary to ensure adequate space for wheelchair users or pedestrians with crutches, walkers, or canes to pass safely and comfortably. Of the 3,511 ramps surveyed for ramp width, the survey team found that: 2,211 (63%) followed best practices with a width greater than or equal to 48"; (ii) 1,199 (34%) followed ADAAG standards with a width of 36-47"; and, 101 (3%) were non-standard with a width of less than 36".

Running slope is measured parallel to the direction of pedestrian travel. Regardless of ramp type, ADAAG requires ramp panel running slopes to measure 8.3% or less. A ramp that is too steep makes it difficult for pedestrians with limited mobility to ascend or descend. Of the 3,511 ramps measured for ramp



ADA Self-Evaluation Report

panel running slope, the survey team found: 1,525 (43%) had standard running slopes of less than 8.3%; 686 (20%) had non-standard running slopes of 8.3-10%; and, 1,300 (37%) had highly non-standard running slopes greater than 10%.

Ramp panel cross slope is measured perpendicular to the direction of travel. Like running slope, excessive cross slope poses a challenge for pedestrians with limited mobility by impairing stability. Regardless of ramp type, ADAAG requires cross slopes of less than 2%. Of the 3,511 ramps measured for ramp panel cross slope, the survey team found: 1,095 (31%) met ADAAG standards with cross slopes of less than 2%; 1,006 (29%) were non-standard with cross slopes of 2-4%; and, 1,410 (40%) were highly non-standard with cross slopes in excess of 4%.

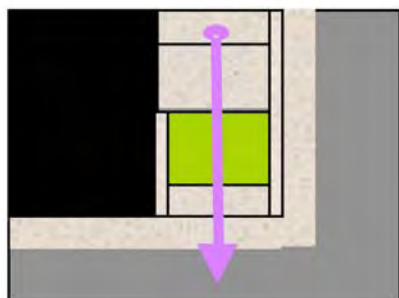
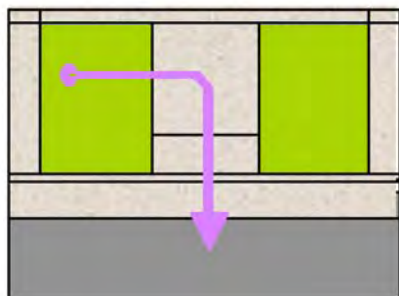
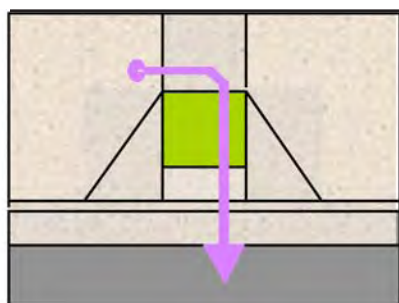

➔ Path of

■ Ramp

Locations: (from top) NE 24th and 164th NE; NE 24th and 167th NE; NE 24th and 167th NE

Curb Ramp Inventory



The following table shows the combined running slope and cross slope statistics for Bellevue's 3,511 curb ramps. As indicated, 502 (14%) curb ramps in Bellevue have both a standard running slope (<8.3%) and standard cross slope (<2%). At the opposite end of the spectrum, 593 (17%) curb ramps in Bellevue have both high running slope (>10%) and high cross slope (>4%). Feedback from the disability community indicates that "warp" (the combined affect of high cross and running slopes) negatively impacts accessibility.

Warp		Ramp Running Slope			Totals
		<8.3% (Standard)	8.3%-10% (Non-Standard)	>10% (Non-Standard)	
Warp is the combination of running and cross slopes. Orange areas indicate high warp.					
Ramp Cross Slope	<2% (Standard)	502 (14%)	224 (6%)	369 (11%)	1,095 (31%)
	2%-4% (Non-Standard)	459 (13%)	209 (6%)	338 (10%)	1,006 (29%)
	>4% (Highly Non-Standard)	564 (16%)	253 (7%)	593 (17%)	1,410 (40%)
	Totals	1,525 (43%)	686 (20%)	1,300 (37%)	3,511 (100%)

The gutter and transition area mark the boundary between the pedestrian zone and the street zone. Compliance is based on gutter running and cross slopes and transition height.

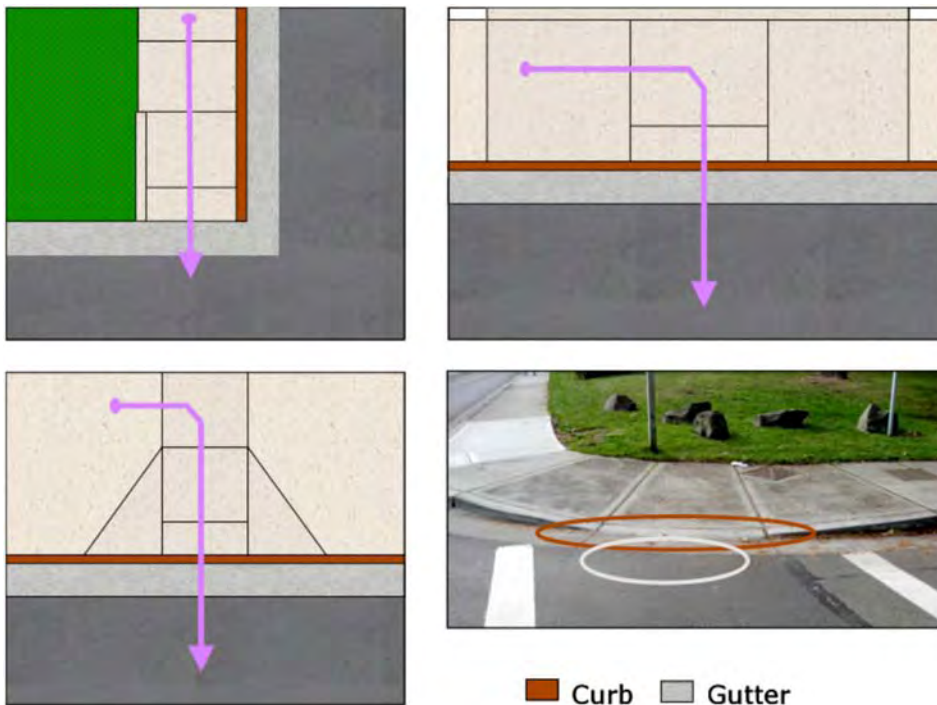



ADA Self-Evaluation Report

- v. *Gutter running slope* is measured in the gutter below the ramp, parallel to the path of travel. Steep gutter running slopes can make it difficult for a person in a wheelchair to make the transition between the ramp and the street. ADAAG requires gutter running slope to be no more than 5%. The survey team found that of the 3,511 ramps measured: 2,362 (67%) had standard gutter running slopes no more than 5%; and, 1,149 (33%) had non-standard gutter running slopes in excess of 5%.
- vi. *Gutter cross slope* is measured in the gutter below the ramp, perpendicular to the path of travel. An excessive gutter cross slope can decrease stability for disabled pedestrians. ADAAG requires gutter cross slope to be no more than 2%. The survey team found that 2,209 ramps, or 63% of the 3,511 measured, had non-standard gutter cross slopes in excess of 2 percent.
- vii. *Transition* is the place where the ramp crosses the curb area to meet the gutter. In addition to contributing to a user's dynamic instability, curb ramp lips will also change the angle of the wheelchair, as if the wheelchair were on an increased grade. For example, if a ramp is designed with an 8.3 percent slope and has a 3/4" lip at the bottom of the ramp, the actual grade the wheelchair user has to negotiate is 11.6 percent. ADAAG requires a smooth transition between the gutter and ramp. The survey team found that 713 (20%) of the 3,511 ramps measured had non-standard transitions.

Detectable warnings, marked crossings, and a clear space at the bottom of a ramp are non-structural safety features.

- viii. *Detectable warning* surfaces are textured pads that provide pedestrians who are blind a tactile warning at the street edge of the change from pedestrian to vehicular way. Detectable warning surfaces are required on all ramps. Standard detectable warnings consist of a 2' by 4' yellow (or other high-contrast color) panel with truncated domes (bumps) located adjacent to the gutter transition. The survey team found that 2,557 (73%) of the 3,511 ramps measured were non-standard because they lacked detectable warnings.
- ix. *Marked crossings* designate the pedestrian path across a street from one curb ramp to another. The survey team found that of the 3,511 ramps measured: 2,869 (82%) had no marked crossings; 500 (14%) had one marked crossing; and, 142 (4%) had two marked crossings.

Curb Ramp Inventory

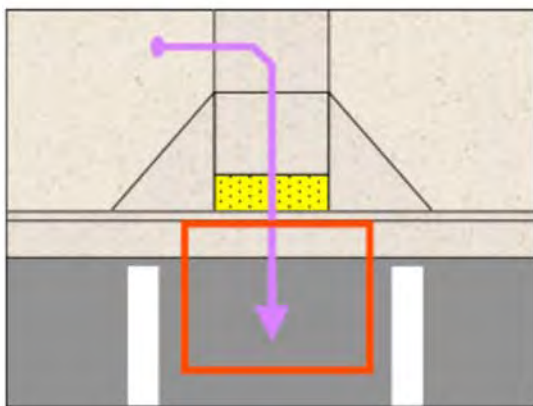
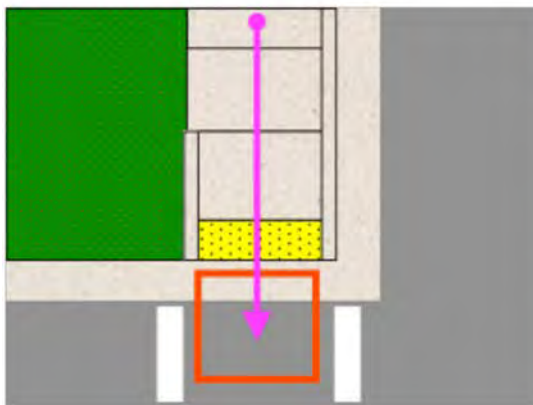
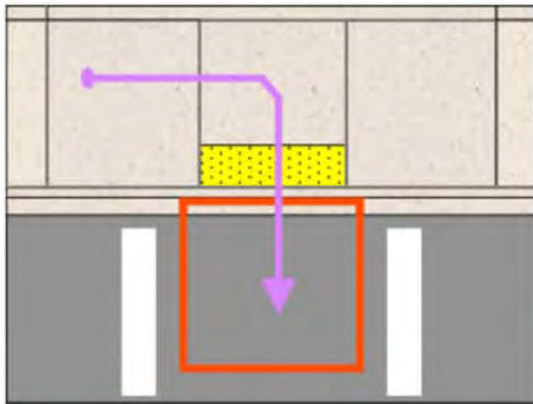

-  Crosswalk
-  Detectable warning
-  Clear Space
-  Path of Travel

- x. *Clear space at bottom* ensures that the marked crossings line up with a ramp and, if there are two crosswalks intersecting, a large clear space ensures a pedestrian enough space to turn around safely out of passing traffic. When there are marked crossings, ADAAG specifies that there must be a clear space at the bottom of the ramp entirely between the marked crossings. The survey team found that 78 of the diagonal ramps were non-standard because they had a clear space of less than 48" at the bottom of the ramps.



ADA Self-Evaluation Report

Curb Ramp Barrier Ranking Analysis



From 2007 to 2009, the City of Bellevue spent in excess of \$2M on curb ramps to make sidewalks accessible to people with disabilities.

The following comment offered by a Bellevue resident, who is blind, during a focus group session conveys the importance of ensuring that ramps are designed to ADA standards.

"The things that help my mobility are ramps that are in predictable locations, oriented toward the opposite side of the street, and in the crosswalk. The ones that are challenges are ramps that are oriented in the diagonal, across the middle of the street. I can't use one of those independently. I have to ask somebody "where is this pointing." I have to train my dog to go to the bottom of the down curb, look for the opposite up curb, and when I tell him forward, he goes to that up curb. If it isn't there, then I have to physically move him, and point where it is I want him to go."

Although ADA tells us which ramp features are non-standard; it does not offer guidance on which non-standard ramp location should be replaced first. The final stage of the ADA Self-Evaluation Report process was to screen the 4,552 ramp locations documented in the field inventory to determine which of these sites required more immediate attention. [Note: This ramp figure excludes the 34 "construction" ramps from analysis as these locations did not have an impedance score].

Curb ramp activity and impedance scores – found in the technical appendix report – were sorted according to their size and divided into three categories (high/medium/low) using natural breaks. The curb ramp natural break categories are as follows: (i) activity score (low = 0-42; medium = 43-59; high = 60-100); and, (ii) impedance score (low = 0-31; medium = 32-69; high = 70-100).

As indicated in the table on page 71, of the 4,552 curb ramp locations recorded in Bellevue:

- 1 percent (the smallest share) had a combined high impedance and high activity score.
- 19 percent (the largest share) had a combined low impedance and medium activity score.

Curb Ramp Inventory



Curb Ramp Activity and Impedance Ranking

Activity	Impedance	Ramps	Percent
High	High	62	1%
High	Medium	272	6%
High	Low	414	9%
Medium	High	484	11%
Medium	Medium	840	18%
Medium	Low	878	19%
Low	High	498	11%
Low	Medium	752	17%
Low	Low	350	8%
Total		4,552	100%

Data for the curb ramp activity and impedance were layered to derive a composite barrier ranking score for a particular block face. Reflected in the table at right are the final results of the barrier ranking analysis; categorized using natural breaks as follows: low = 0-80; medium = 81-117; high = 118-200. As indicated, 24 percent (the smallest share) had a high barrier ranking.

Curb Ramp Barriers Ranking Score

Barrier Ranking	Curb Ramps	Percent
High	1,111	24%
Medium	1,829	40%
Low	1,612	35%
Total	4,552	100%

The following Main Street locations in the curb ramp inventory received the three highest barrier ranking scores: Curb ID: 1881 at 106th Avenue NE; Curb ID: 1885 at 107th Avenue SE; and, Curb ID: 1887 at 107th Avenue NE. Each of these locations received a high impedance score (100 points) because ramps are missing and they have a high activity score (81 points) because this location serves as a major connection to many destinations in downtown Bellevue.



ADA Self-Evaluation Report



In 2008, the City of Bellevue initiated a conceptual design project for Main Street from Bellevue Way to 116th Avenue NE. Work includes lane configuration options, enhanced pedestrian-bicycle facilities, potential open space opportunities and a framework for downtown gateways. The early-stage designs of proposed projects along this corridor all include accessibility enhancements, including the ramp locations identified in the ADA Self-Evaluation Report.